

版本	变更摘要	日期
0	新产品发行	2021/06/03

序号	品名	材质
①	WH3_96立式WTB胶芯	LCP 本色
②	WH3_96立式WTB端子	铜合金/表面镀锡
③	WH3_96立式WTB焊片	铜合金/表面镀锡
④	WH3_96立式WTB吸盖	LCP 本色/黑色

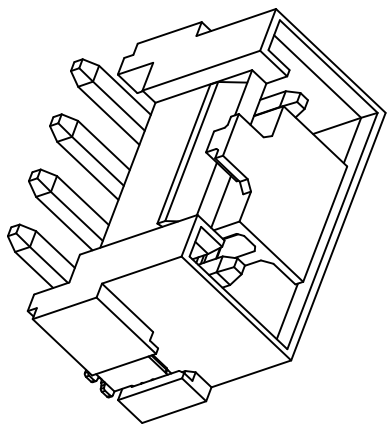

技术指标:

1. 塑件表面应光洁、无毛边、无明显收缩、缺陷、裂纹等现象
2. 温度范围: -25°C~85°C
3. 额定电压: 250V, AC DC.
4. 额定电流: 7.0 A, AC DC.
5. 接触电阻:  $\leq 30m\Omega$  Min
5. 绝缘电阻:  $\geq 1000M\Omega$ .
6. 耐压值: 1500V AC/minute
6. 产品料号: WT396VL

NO OF CKT (产品PIN数)

Plating (电镀方式)

0: 端子全雾锡

1: 端子全金 (G/F OVERALL)

4: 端子全亮锡

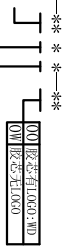

Packing (包装方式)  
R: TAPE & REEL 卷装  
C: TAPERBAG, WITH COVER 加放吸卷袋

CKT	A	B	C	D	E
2	3.96	8.68	10.18	11.84	3.88
3	7.92	12.64	14.14	15.80	7.84
4	11.88	16.60	18.10	19.76	
5	15.84	20.56	22.06	23.72	
6	19.80	24.52	26.02	27.68	
7	23.76	28.48	29.98	31.64	
8	27.72	32.44	33.94	35.60	
9	31.68	36.40	37.90	39.56	
10	35.64	40.36	41.86	43.52	10.00
11	39.60	44.32	45.82	47.48	
12	43.56	48.28	49.78	51.44	
13	47.52	52.24	53.74	55.40	
14	51.48	56.20	57.70	59.36	
15	55.44	60.16	61.66	63.32	
16	59.40	64.12	65.62	67.28	

适用线路板 (厚度: 0.8mm~1.6mm)

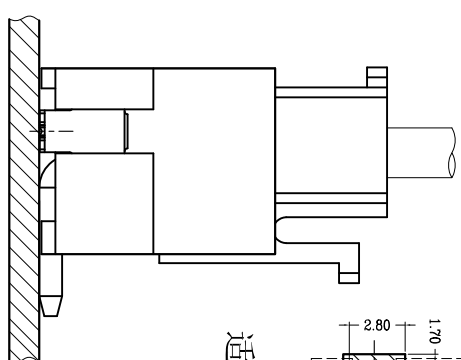
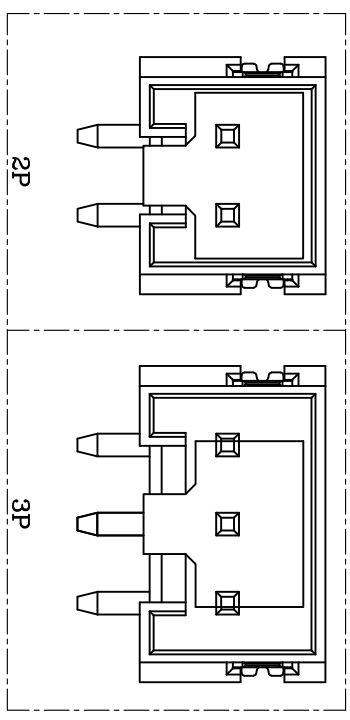
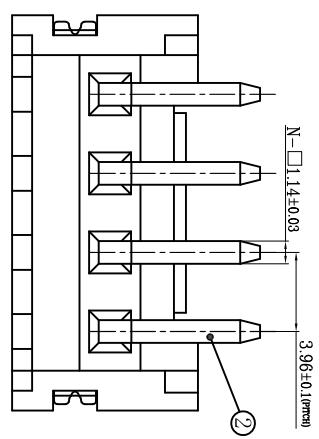
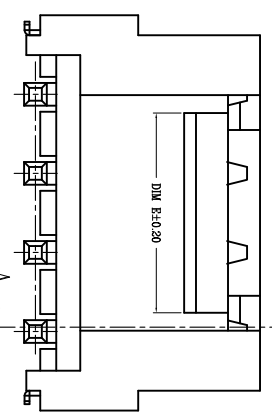
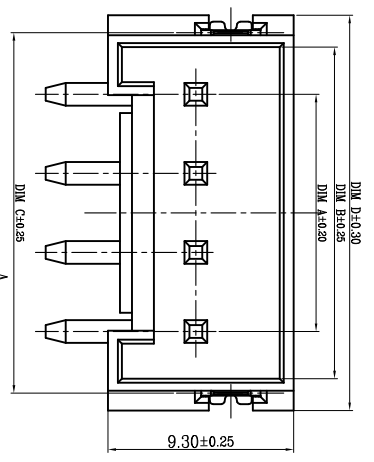
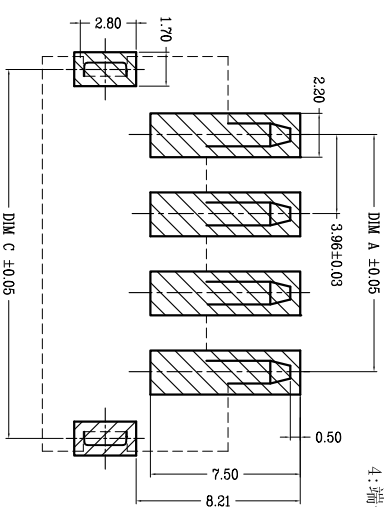

Assembly Layout



一般公差 (TOLERANCE)  
X: ±.50 XX: ±.10  
Y: ±.20 XXX: ±.05  
ANGLES ±1°

深圳市虹成电子有限公司

品名 (TITLE) WH3\_96立式WTB业务图

料号 (DWG.NO) HCZZ0596-8

比例 (SCALE) 1:1

制图 (DR) ANLAN

校对 (CHKD) 李绍宗

审核 (APPD) 黄志明

张数 (SHEET) 1 Of 1

尺寸 (SIZE) A4