

版本	变更摘要	日期	序号	品名	材质
0	新产品发行	2021/06/03	1	WH3.96立式WTB胶芯	LCP 本色
			2	WH3.96立式WTB端子	铜合金/表面镀锡
			3	WH3.96立式WTB焊片	铜合金/表面镀锡
			4	WH3.96立式WTB吸盖	LCP 本色/黑色

1	WH3.96立式WTB胶芯	LCP 本色
2	WH3.96立式WTB端子	铜合金/表面镀锡
3	WH3.96立式WTB焊片	铜合金/表面镀锡
4	WH3.96立式WTB吸盖	LCP 本色/黑色

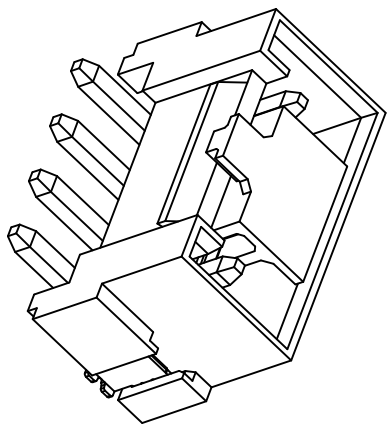
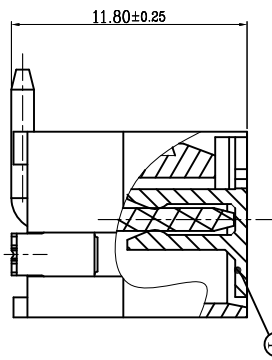
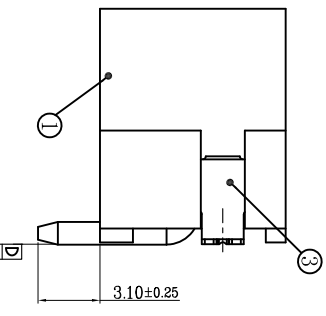
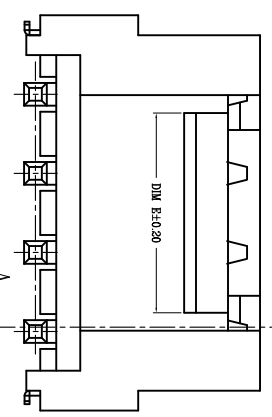
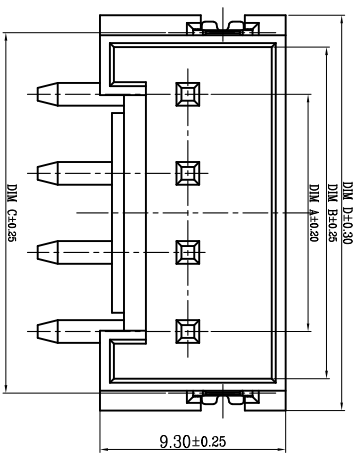

技术指标:

1. 塑件表面应光洁、无毛边、无明显收缩、缺陷、裂纹等现象。
2. 温度范围: -25°C~85°C。
3. 额定电压: 250V, AC DC。
4. 额定电流: 7.0 A, AC DC。
5. 接触电阻: ≤30mΩ Min
5. 绝缘电阻: ≥1000MΩ。
6. 耐压值: 1500V AC/minute
6. 产品料号: WT396VL—** *—**

NO OF CKT (产品PIN数)
Plating (电镀方式)
0: 端子全雾锡
1: 端子全金 (G/F OVERALL)
4: 端子全亮锡

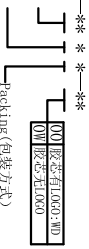

Packing (包装方式)
R: TAPE & REEL 卷装
C: TAPERBAG, WITH COVER 加放纸卷袋

CKT	A	B	C	D	E
2	3.96	8.68	10.18	11.84	3.88
3	7.92	12.64	14.14	15.80	7.84
4	11.88	16.60	18.10	19.76	
5	15.84	20.56	22.06	23.72	
6	19.80	24.52	26.02	27.68	
7	23.76	28.48	29.98	31.64	
8	27.72	32.44	33.94	35.60	
9	31.68	36.40	37.90	39.56	
10	35.64	40.36	41.86	43.52	10.00
11	39.60	44.32	45.82	47.48	
12	43.56	48.28	49.78	51.44	
13	47.52	52.24	53.74	55.40	
14	51.48	56.20	57.70	59.36	
15	55.44	60.16	61.66	63.32	
16	59.40	64.12	65.62	67.28	

适用线路板 (厚度: 0.8mm~1.6mm)

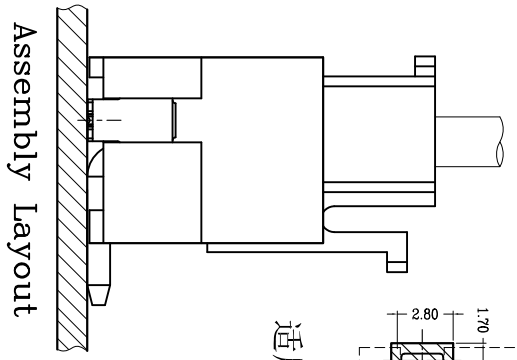
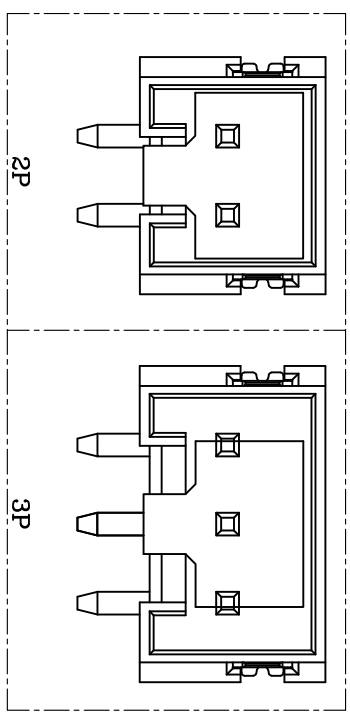
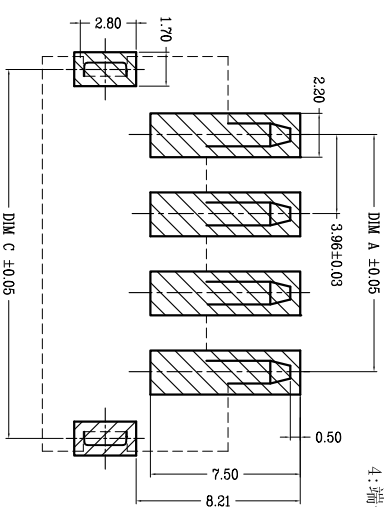

一般公差 (TOLERANCE)
X: ±.50 XX: ±.10
Y: ±.20 XXX: ±.05
ANGLES ±1°

深圳市虹成电子有限公司

品名 (TITLE) WH3.96立式WTB业务图
料号 (DWG.NO) HCZZ0596-7
比例 (SCALE) 1:1

制图 (DR)	ANLAN
校对 (CHKD)	李绍宗
审核 (APPD)	黄志明
张数 (SHEET)	1 Of 1
尺寸 (SIZE)	A4
版本 (REV)	A