

版次 (Ed)	变更摘要 (Change The Content)	日期 (Date)	序号 (NO.)	品名 (Name)	材质 (Material)
0	新产品发行 (New Product Launch)	2017/09/06	①	2.00 F型端子2代(WTB)胶芯 2.00 Pitch R/A Wire To Board Housing (H=5.2)	LCP 本色 Natural

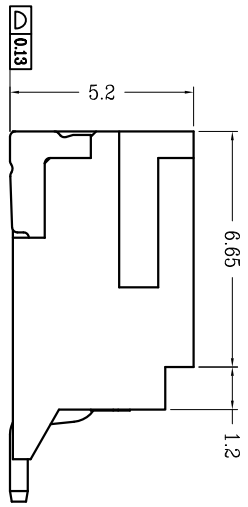
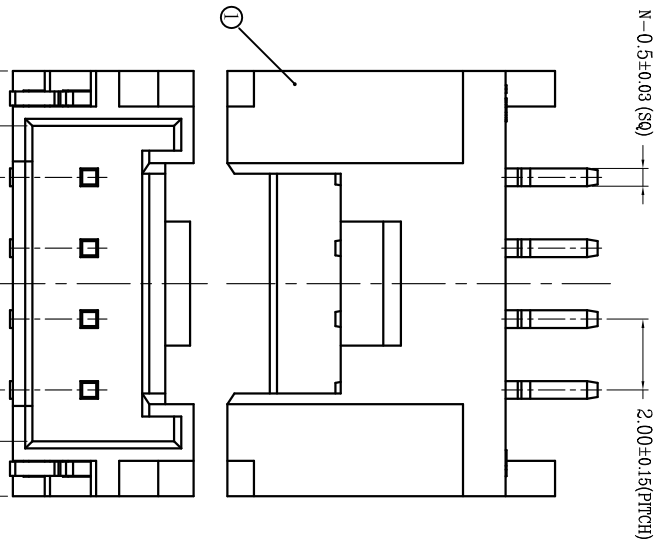
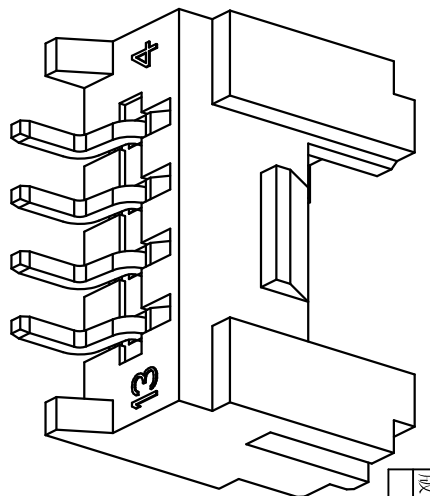

技术指标 (Technical Index):

1. 塑件表面应光洁、无毛边、无明显收缩、缺陷、裂纹等现象。
(The surface of the plastic parts should be smooth, no rough edges, no obvious shrinkage, defects, cracks and other phenomena)
2. 温度范围 (Temperature range): -40° C~+85° C.
3. 额定电压 (Rated voltage): 200V, AC.
4. 接触电阻 (Contact resistance): ≤55mΩ (Initial) per contact, ≤25mΩ Change allowed.
5. 绝缘电阻 (Insulation resistance): ≥1000MΩ.
6. 产品料号 (Product material No.):

WT200FW—** *—2*
NO OF CKT (产品PIN数)
Plating (电镀方式)

- 1: 端子全金 (Terminal G/F OVER ALL)
- 4: 端子全亮锡 (Terminal all bright tin)

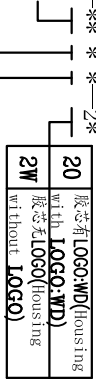

Packing (包装方式)
T: TUBE管装
R: TAPE & REEL卷装

CKT	DIM A	DIM B	DIM C
2	2.00	4.90	8.00
3	4.00	6.90	10.00
4	6.00	8.90	12.00
5	8.00	10.90	14.00
6	10.00	12.90	16.00
7	12.00	14.90	18.00
8	14.00	16.90	20.00
9	16.00	18.90	22.00
10	18.00	20.90	24.00
11	20.00	22.90	26.00
12	22.00	24.90	28.00
13	24.00	26.90	30.00
14	26.00	28.90	32.00
15	28.00	30.90	34.00
16	30.00	32.90	36.00
17	32.00	34.90	38.00
18	34.00	36.90	40.00
19	36.00	38.90	42.00
20	38.00	40.90	44.00

适用线路板 (PCB LAYOUT)

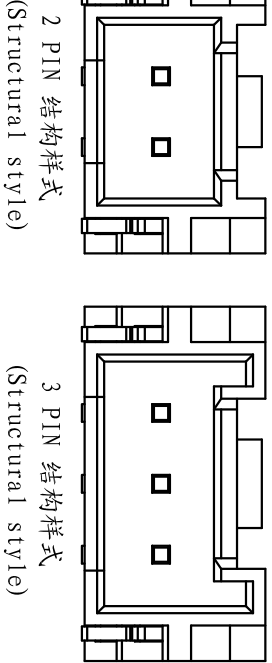
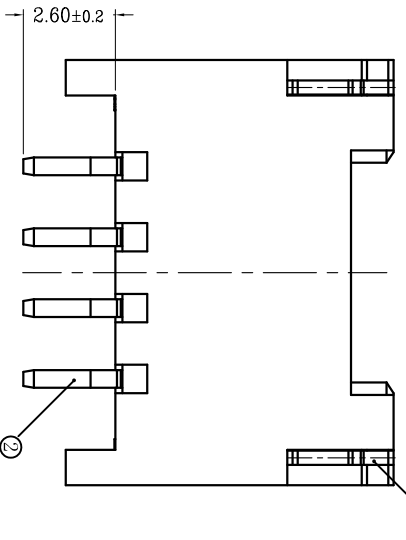
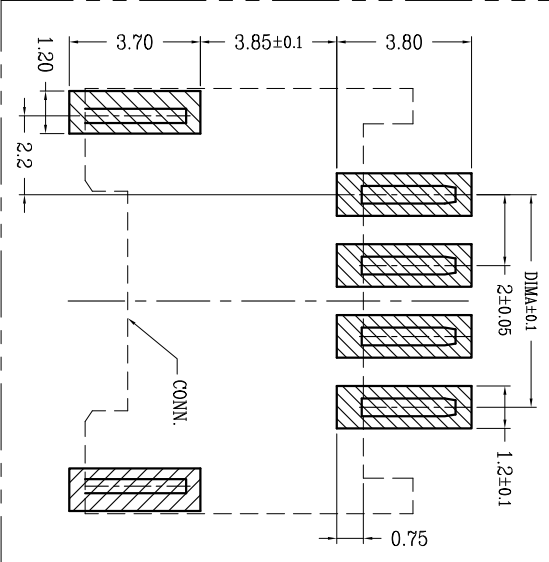

深圳市虹成电子有限公司



一般公差 (TOLERANCE)
X ±.50 XX ±.10
X ±.20 XXX ±.05
ANGLES ±1°

品名 (TITLE)	2.00 Pitch F型卧式2代WTB	制图 (DR)	Anlan
料号 (DWGNO)	HCZZ0383-3	校对 (CHKD)	王涛
比例 (SCALE)	1:1	审核 (APPD)	黄志明
单位 (UNITS)	mm	张数 (SHEET)	1 Of 1
尺寸 (SIZE)	A4	版数 (REV)	A