

RoHS 2.0

REV.	ECN NO.	DESCRIPTION	DATE	DESIGN
A0.	/.	新版发行	2020.05.04	Yang
A1.	/.	重新核对图面	21.01.07	LiHui

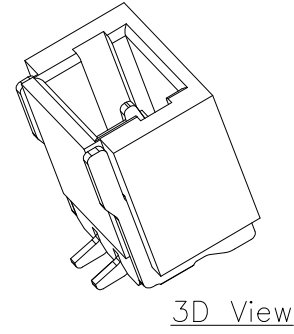

PIN数	A±0.1	B±0.1	C±0.1
2P	4.30	1.00	3.25
3P	5.30	2.00	4.25
4P	6.30	3.00	5.25
5P	7.30	4.00	6.25
6P	8.30	5.00	7.25

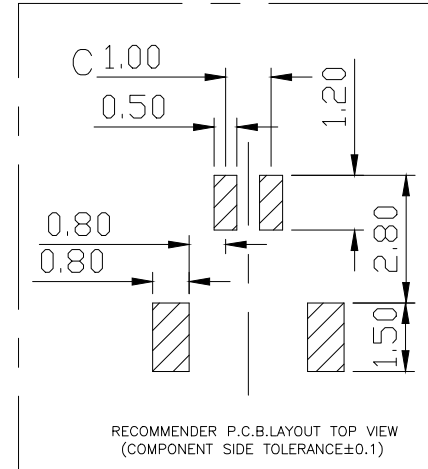
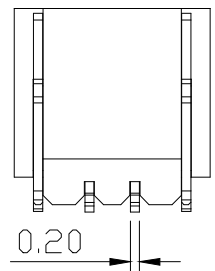
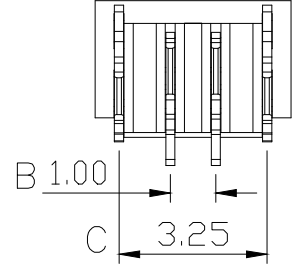
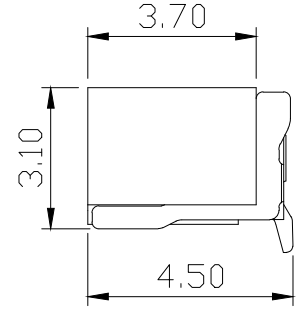
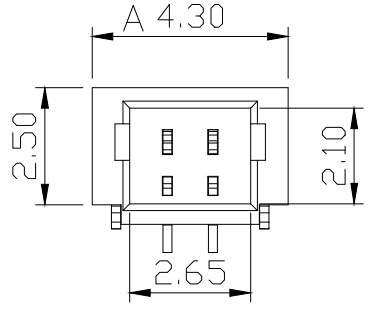
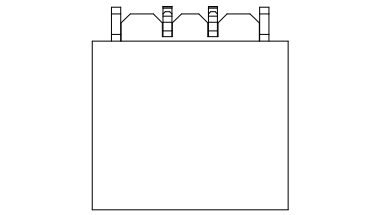

Specifications:

1. Rated Voltage : 50V AC/DC
2. Rated Current : 1A AC,DC
3. Withstand Voltage : 200V AC/minute
4. Contact Resistance : 50mΩ(MAX.)
5. Insulation Resistance : 100MΩ(MIN.)
6. Storage Temperature Range: -40°C~+85°C;
7. Operation Temperature Range: -25°C~+70°C;

3	插片	黄铜H65	镀镍锡	
2	插针	黄铜H65	镀镍锡	
1	底座	LCP	本色	
序号	品名	材质	电镀/颜色	备注

## 深圳市虹成电子有限公司

UNLESS OTHERWISE, GENERAL TOLERANCE: X. xxx ±0.05 X. xx ±0.15 X. x ±0.25	NAME:	P/N: HCZZ0039-2				
	针座1.0立贴2P编带		DWG NO:			
ANGULAR: X. xx° ±1° X. x° ±3° X. ° ±5°	THIRD ANGLE PROJECTION	UNIT:	SCALE	SIZE:	SHEET:	REV.
		MM	1:1	A4	1/1	A1
DRAWN:		CHECKED:		APPROVED:		