

标记 MARK	ECN编号/变更内容 ECN NO/DEFINITION	修改 REVISE	日期 DATE	核准 APPROVE

CKI	DIM A	DIM B	DIM C	DIM D	DIM E
2	3.96	8.68	10.18	11.84	3.88
3	7.92	12.64	14.14	15.80	7.84
4	11.88	16.60	18.10	19.76	10.00
5	15.84	20.56	22.06	23.72	10.00
6	19.80	24.52	26.02	27.68	10.00
7	23.76	28.48	29.98	31.64	10.00
8	27.72	32.44	33.94	35.60	10.00
9	31.68	36.40	37.90	39.56	10.00
10	35.64	40.36	41.86	43.52	10.00
11	39.60	44.32	45.82	47.48	10.00
12	43.56	48.28	49.78	51.44	10.00
13	47.52	52.24	53.74	55.40	10.00
14	51.48	56.20	57.70	59.36	10.00
15	55.44	60.16	61.66	63.32	10.00
16	59.40	64.12	65.62	67.28	10.00

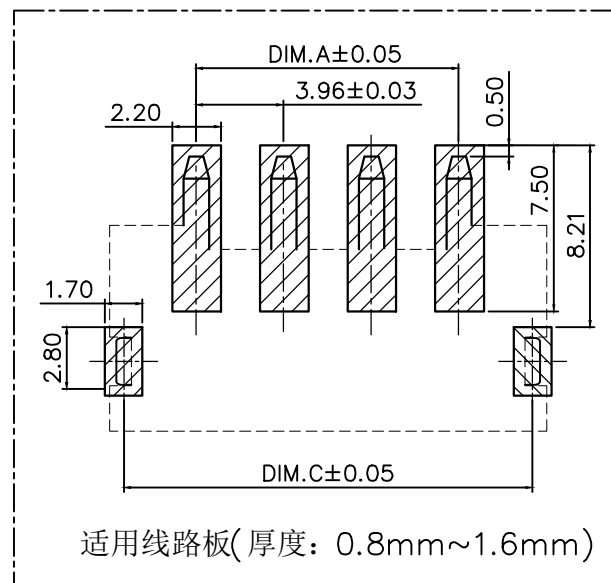
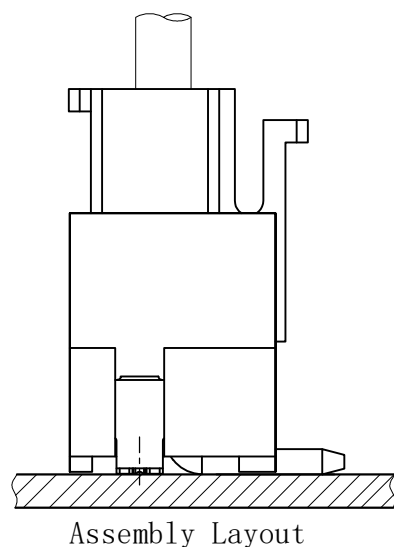
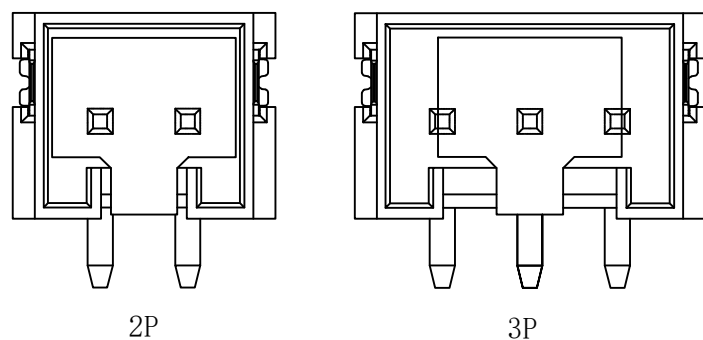
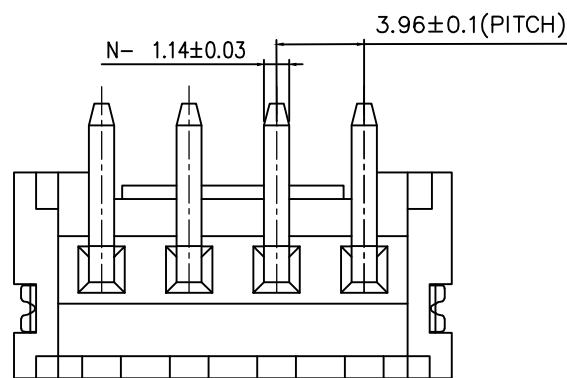
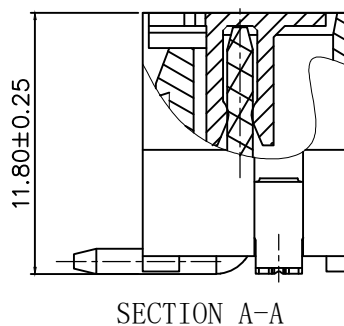
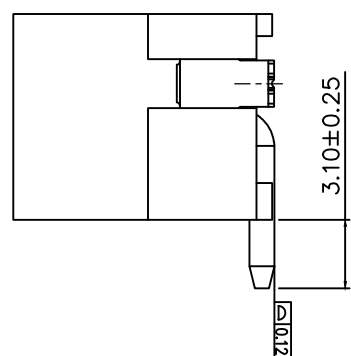
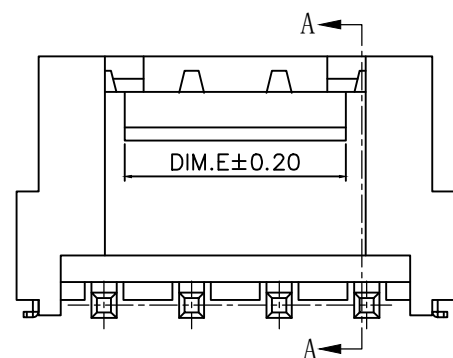
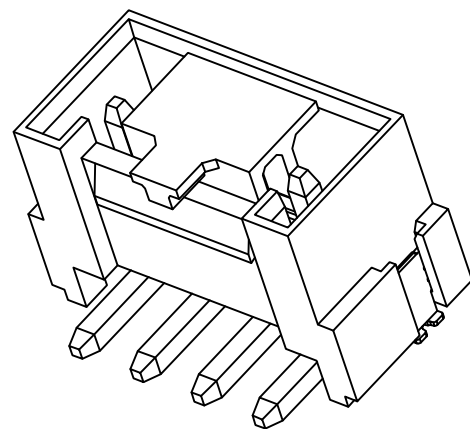
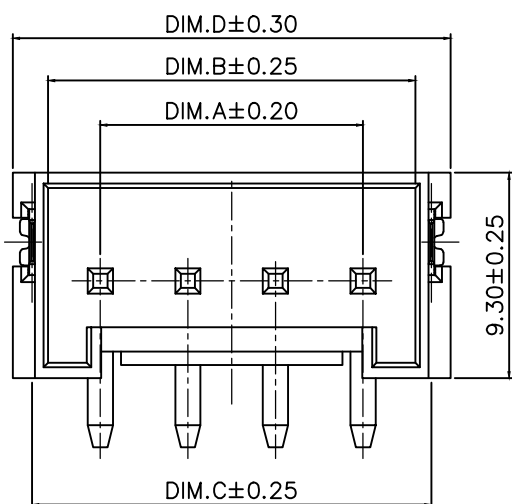

技术指标:

1. 温度范围: -25°C~+85°C
2. 额定电压: 250V, AC/DC
3. 额定电流: 7.0A AC,DC
4. 接触电阻: ≤30mΩ Min
5. 耐压: 1500V AC/minute
6. 绝缘电阻: ≥1000MΩ

序号	品名	材质	电镀/颜色	备注
2	插针	铜	镀锡	
1	基座	LCP	本色	

	深圳市虹成电子有限公司		品名 TITLE	针座	
			料号 PART NO	HCZZ0596-2	
GENERAL TOLERANCES (UNLESS SPECIFIED)		比列 SCALE	1:1		
X. ±0.50 .XX ±0.10		单位 UNIT	MM		
.X ±0.20 .XXX ±0.05		张数 PART NO	1 OF 1	制图 DRAW	AhYe
ANGLES ±1°		版本 REV	A	审核 CHECKED	夏操云
				批准 APPROVE	赵亮亮

