

标记 MARK	ECN编号/变更内容 ECN NO/DEFINITION	修改 REVISE	日期 DATE	核准 APPROVE

CKI	DIM A	DIM B	DIM C	DIM D	DIM E
2	3.96	8.68	10.61	11.88	3.88
3	7.92	12.64	14.57	15.84	7.84
4	11.88	16.60	18.53	19.80	10.00
5	15.84	20.56	22.49	23.76	10.00
6	19.80	24.52	26.45	27.72	10.00
7	23.76	28.48	30.41	31.68	10.00
8	27.72	32.44	34.37	35.64	10.00
9	31.68	36.40	38.33	39.60	10.00
10	35.64	40.36	42.29	43.56	10.00
11	39.60	44.32	46.25	47.52	10.00
12	43.56	48.28	50.21	51.48	10.00
13	47.52	52.24	54.17	55.44	10.00
14	51.48	56.20	58.13	59.40	10.00
15	55.44	60.16	62.09	63.36	10.00
16	59.40	64.12	66.05	67.32	10.00

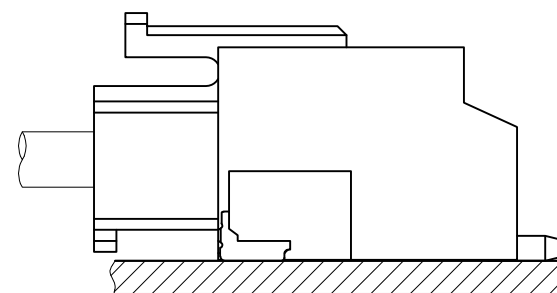
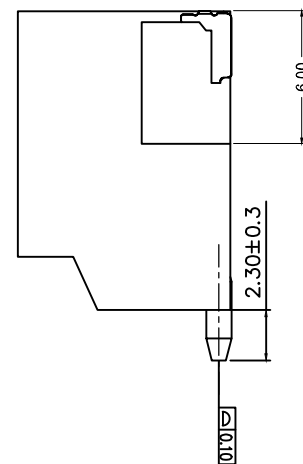
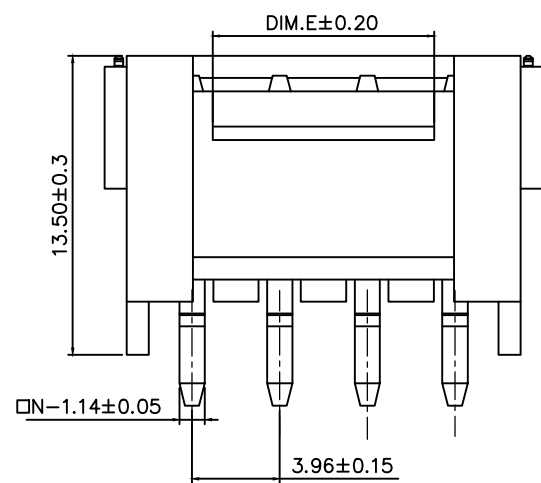
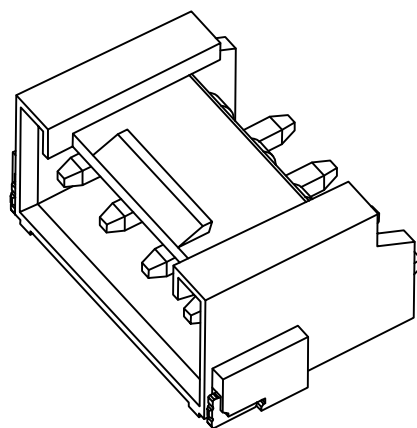
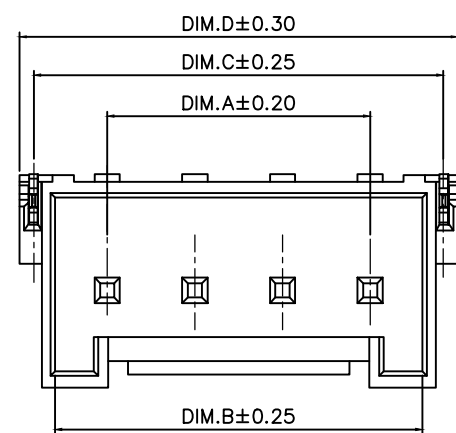

Assembly Layout

技术指标:

1. 温度范围:  $-25^{\circ}\text{C} \sim +85^{\circ}\text{C}$
2. 额定电压: 250V, AC/DC
3. 额定电流: 7.0A AC,DC
4. 接触电阻:  $\leq 30\text{m}\Omega$  Min
5. 耐压: 1500V AC/minute
6. 绝缘电阻:  $\geq 1000\text{M}\Omega$

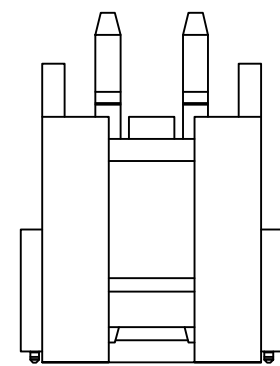
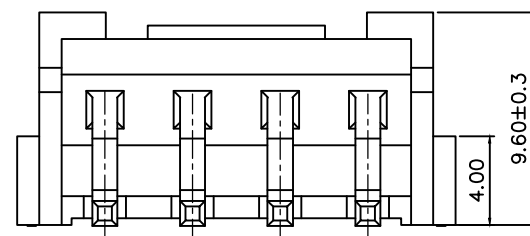

2P

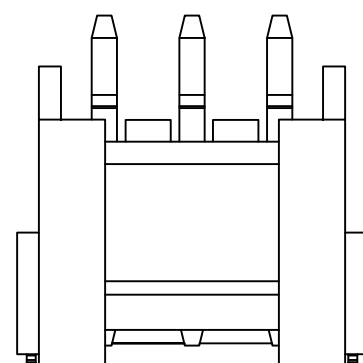

3P

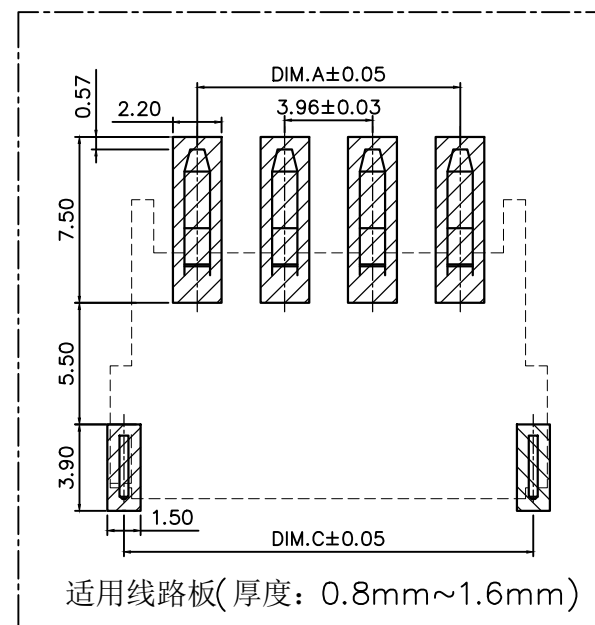

2	插针	铜	镀锡	
1	基座	LCP	本色	
序号	品名	材质	电镀/颜色	备注

	深圳市虹成电子有限公司 SHENZHEN HONGCHENG ELECTRONICS CO., LTD.		品名 TITLE	针座	
			料号 PART NO	HCZZ0590-5	
GENERAL TOLERANCES (UNLESS SPECIFIED)		比列 SCALE	1:1		
X. ±0.50	.XX ±0.10	单位 UNIT	MM	制图 DRAW	AhYe
.X ±0.20	.XXX ±0.05	张数 PART NO	1 OF 1	审核 CHECKED	夏操云
ANGLES ±1°		版本 REV	A	批准 APPROVE	赵亮亮

