

标记 MARK	ECN编号/变更内容 ECN NO/DEFINITION	修改 REVISE	日期 DATE	核准 APPROVE

CKI	DIM A	DIM B	DIM C
2	2.50	7.50	10.00
3	5.00	10.00	12.50
4	7.50	12.50	15.00
5	10.00	15.00	17.50
6	12.50	17.50	20.00
7	15.00	20.00	22.50
8	17.50	22.50	25.00
9	20.00	25.00	27.50
10	22.50	27.50	30.00
11	25.00	30.00	32.50
12	27.50	32.50	35.00
13	30.00	35.00	37.50
14	32.50	37.50	40.00
15	35.00	40.00	42.50
16	37.50	42.50	45.00

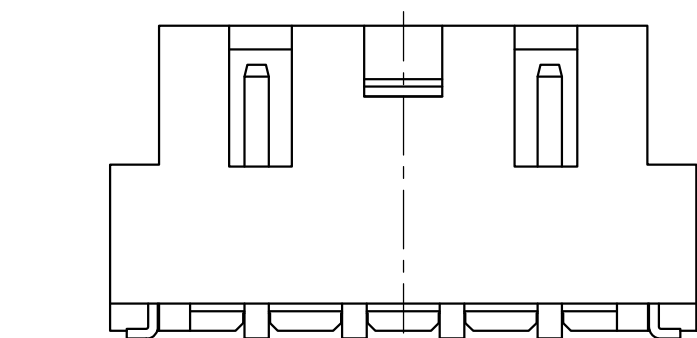

2~5P 结构样式

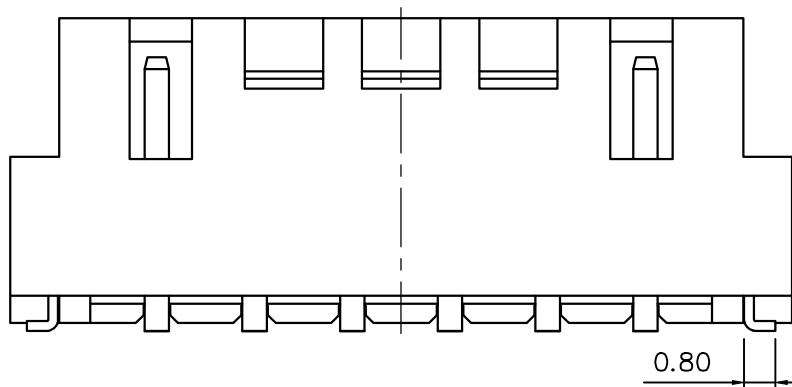
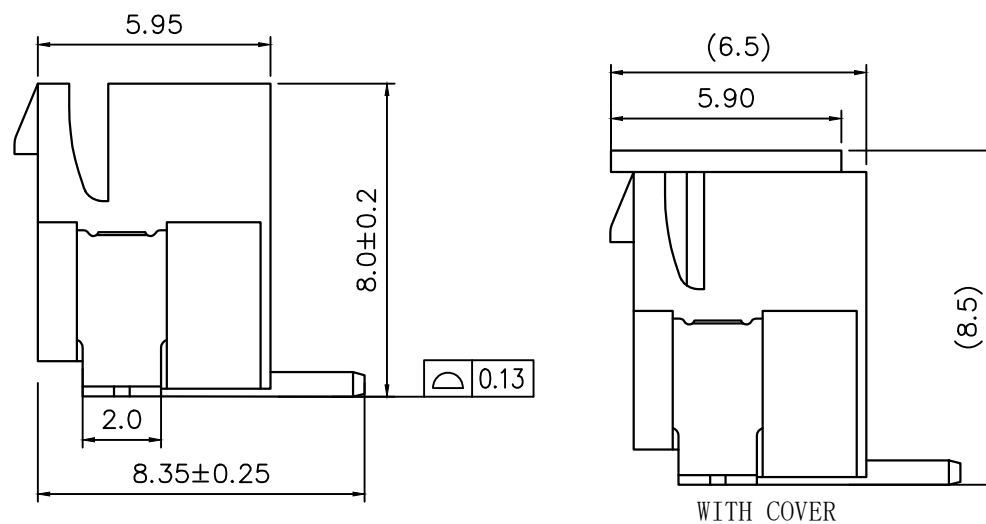
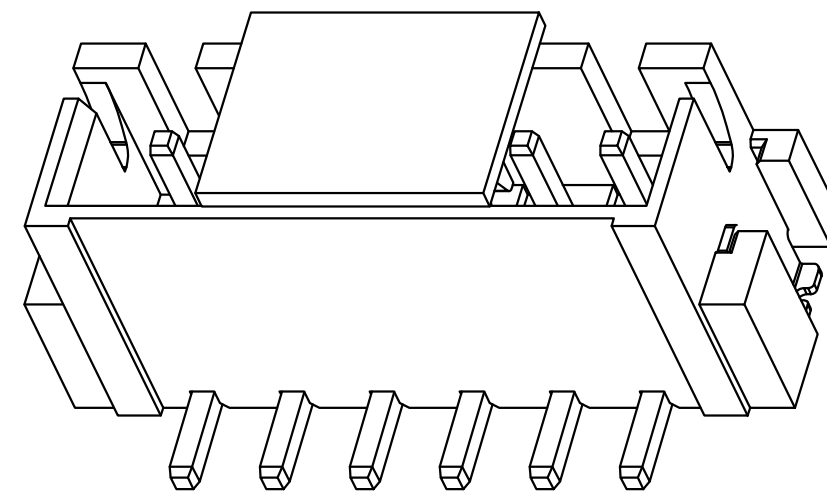
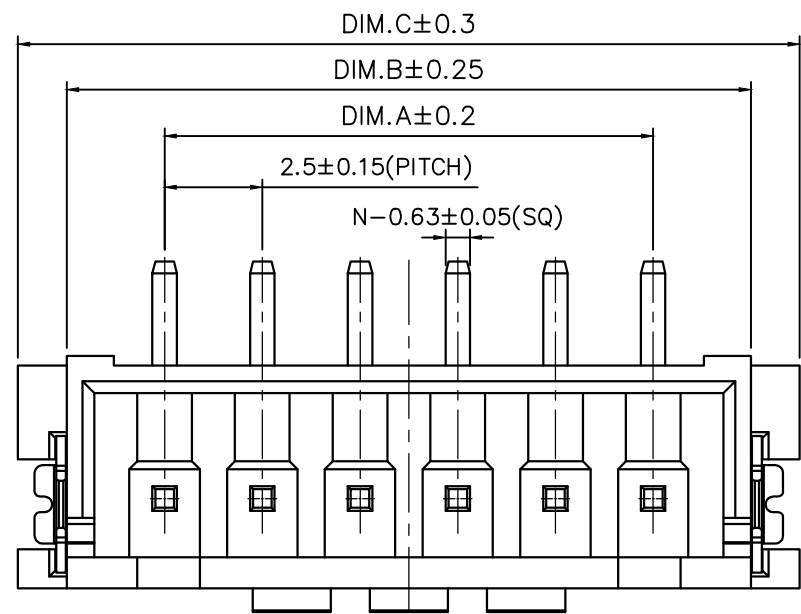
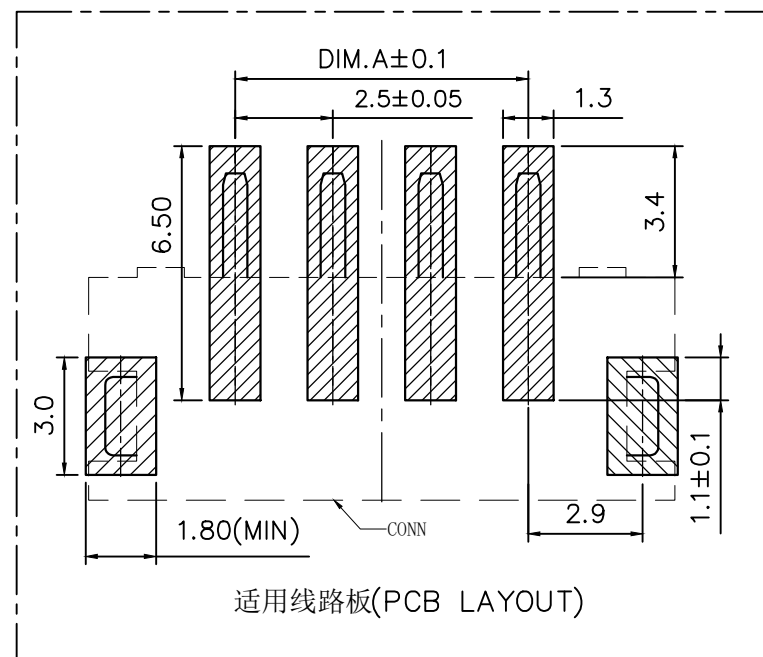

技术指标:

1. 工作温度: -25°C~85°C
2. 额定电压: 250V, DC/AC(rms)
3. 额定电流: 3.0A
4. 接触电阻: ≤20mΩ
5. 耐压: 1000V AC/minute
6. 绝缘电阻: ≥1000MΩ
7. 适用线规: AWG#30~#22

序号	品名	材质	电镀/颜色	备注
2	插针	铜	镀锡	
1	基座	LCP	本色	

	深圳市虹成电子有限公司		品名 TITLE	针座	
			料号 PART NO	HCZZ0040-4	
GENERAL TOLERANCES (UNLESS SPECIFIED)		比列 SCALE	1:1		
X. ±0.50 .XX ±0.10		单位 UNIT	MM		
.X ±0.20 .XXX ±0.05		张数 PART NO	1 OF 1	制图 DRAW	AhYe
ANGLES ±1°		版本 REV	A	审核 CHECKED	夏操云
				批准 APPROVE	赵亮亮

