

标记 MARK	ECN编号/变更内容 ECN NO/DEFINITION	修改 REVISE	日期 DATE	核准 APPROVE

PIN	DIM A	DIM B	DIM C
2P	10.00	6.10	2.50
3P	12.50	8.60	5.00
4P	15.00	11.10	7.50
5P	17.50	13.60	10.00
6P	20.00	16.10	12.50

A

A

DIM A 12.50±0.20

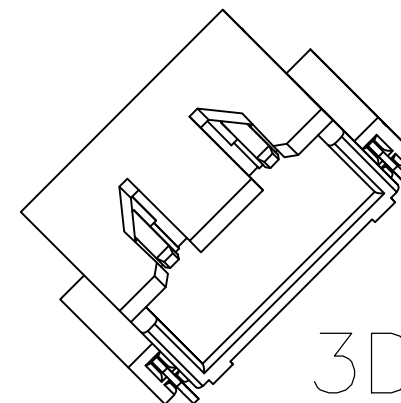
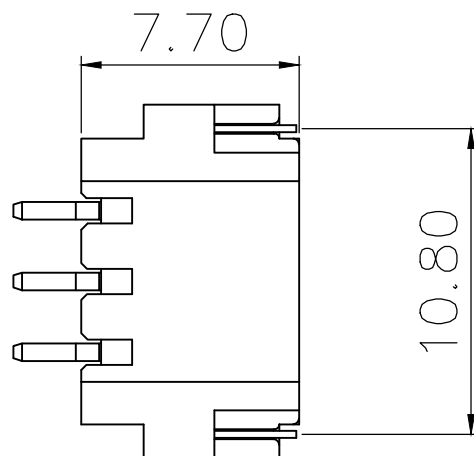
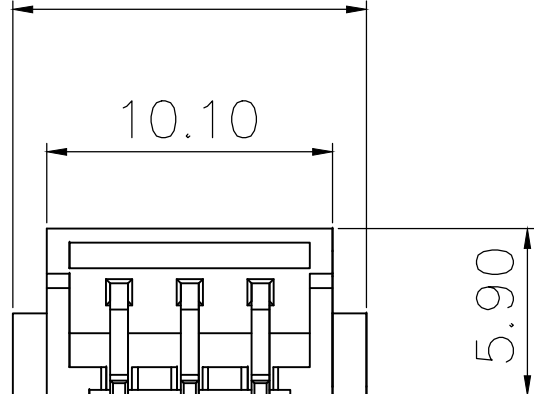

B

B

C

C

DIM B 8.60

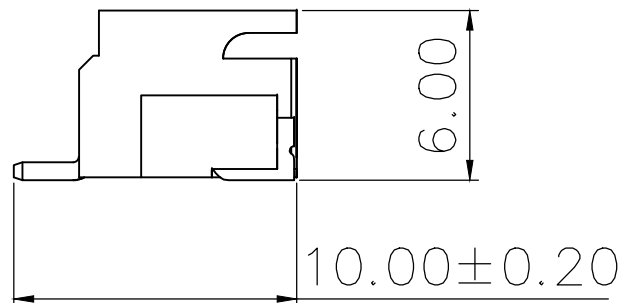
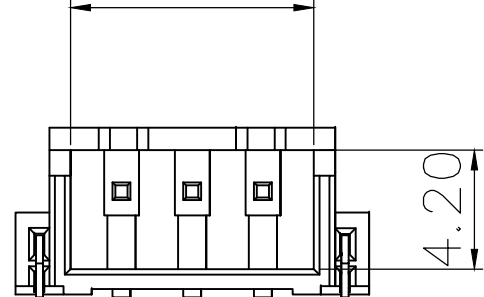

SPECIFICATION

- 1.Contact resistance: ≤10MΩ
- 2.Insulation resistance: ≥1000MΩ
- 3.Rated voltage: 250 V AC DC
- 4.Rated current: 3.0 A AC DC
- 5.Withstand Voltage: 1000V AC/minute
- 6.Temperature Range : -25°C~+85°C

D

D

E

E

DIM C 5.00

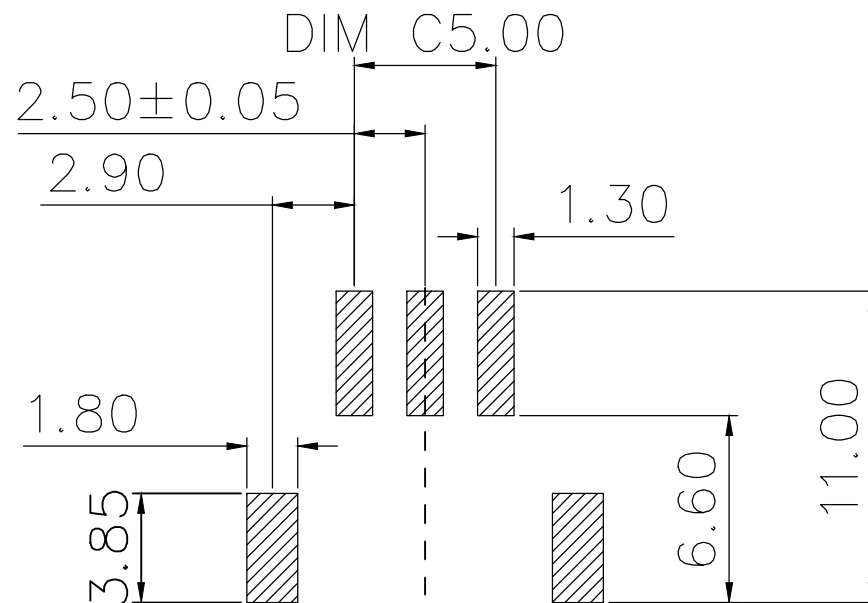
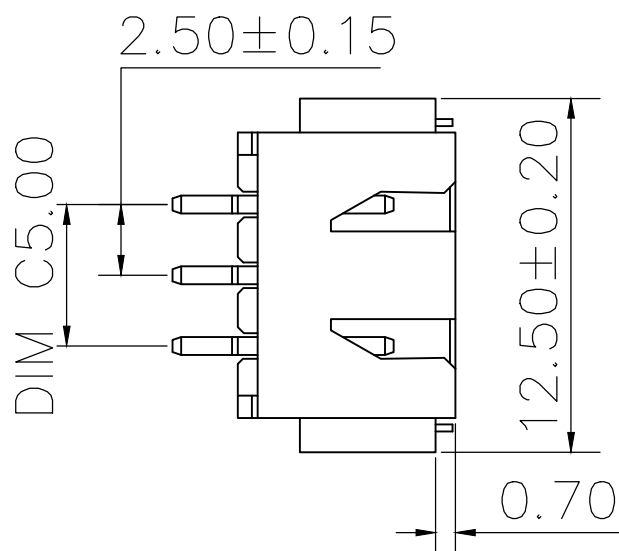

RECOMMENDER P.C.B.LAYOUT TOP VIEW (COMPONENT SIDE TOLERANCE±0.1)

2	插针	铜	镀镍锡	
1	基座	LCP	本色	
序号	品名	材质	电镀/颜色	备注

	深圳市虹成电子有限公司		品名 TITLE	针座
			料号 PART NO	HCZZ0021-3

UNLESS OTHERWISE, GENERAL TOLERANCE:	比列 SCALE	1:1		
X. xxx ±0.10	单位 UNIT	MM	制图 DRAW	AhYe
X. xx ±0.20	张数 PART NO	1 OF 1	审核 CHECKED	夏操云
X. x ±0.30	版本 REV	A	批准 APPROVE	赵亮亮
ANGULAR:				
X. xx° ±1°				
X. x° ±3°				
X. ° ±5°				



G

G