

| 标记 MARK | ECN编号/变更内容 ECN NO/DEFINITION | 修改 REVISE | 日期 DATE | 核准 APPROVE |
|------------|---------------------------------|--------------|------------|---------------|
| | | | | |
| | | | | |

| CKI | DIM A | DIM B | DIM C |
|-----|-------|-------|-------|
| 2 | 2.00 | 4.90 | 8.00 |
| 3 | 4.00 | 6.90 | 10.00 |
| 4 | 6.00 | 8.90 | 12.00 |
| 5 | 8.00 | 10.90 | 14.00 |
| 6 | 10.00 | 12.90 | 16.00 |
| 7 | 12.00 | 14.90 | 18.00 |
| 8 | 14.00 | 16.90 | 20.00 |
| 9 | 16.00 | 18.90 | 22.00 |
| 10 | 18.00 | 20.90 | 24.00 |
| 11 | 20.00 | 22.90 | 26.00 |
| 12 | 22.00 | 24.90 | 28.00 |
| 13 | 24.00 | 26.90 | 30.00 |
| 14 | 26.00 | 28.90 | 32.00 |
| 15 | 28.00 | 30.90 | 34.00 |
| 16 | 30.00 | 32.90 | 36.00 |

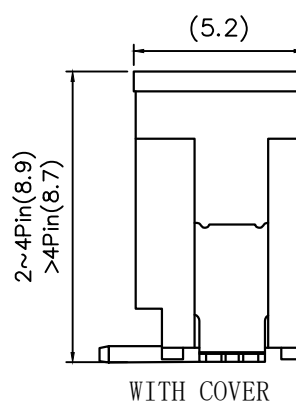
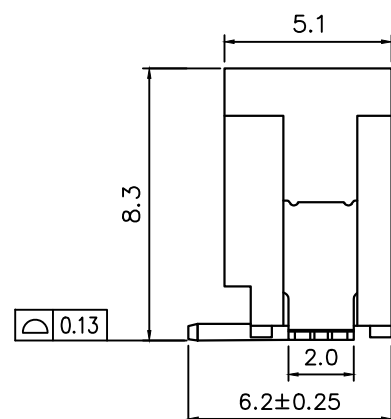
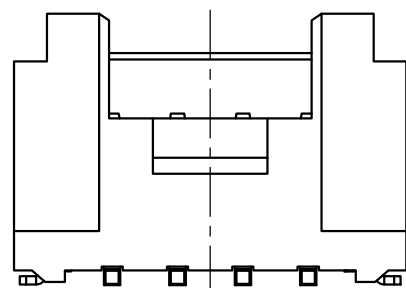
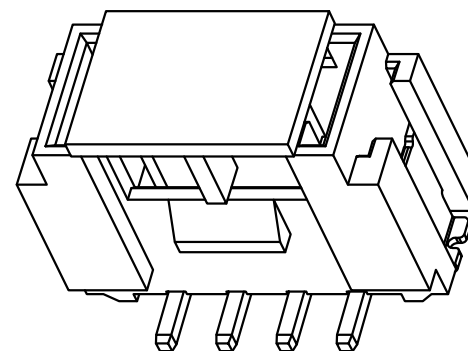
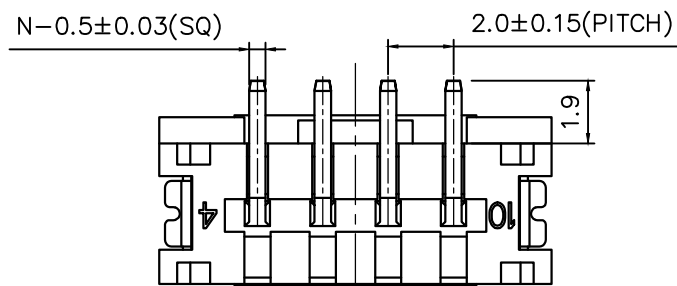
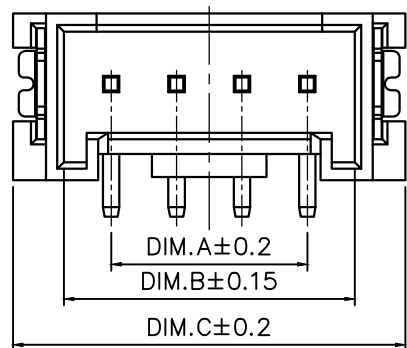

技术指标:

1. 温度范围: -40°C~85°C
2. 额定电压: 200V, AC
3. 接触电阻: ≤55mΩ (Initial) per contact
≤25mΩ Change allowed
4. 绝缘电阻: ≥1000MΩ

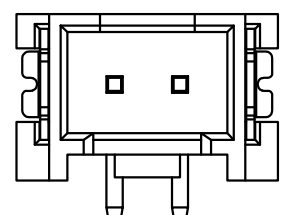

2P 结构样式

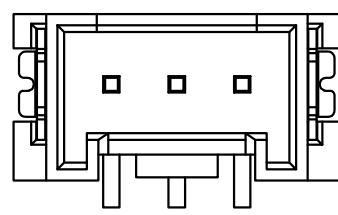

3P 结构样式

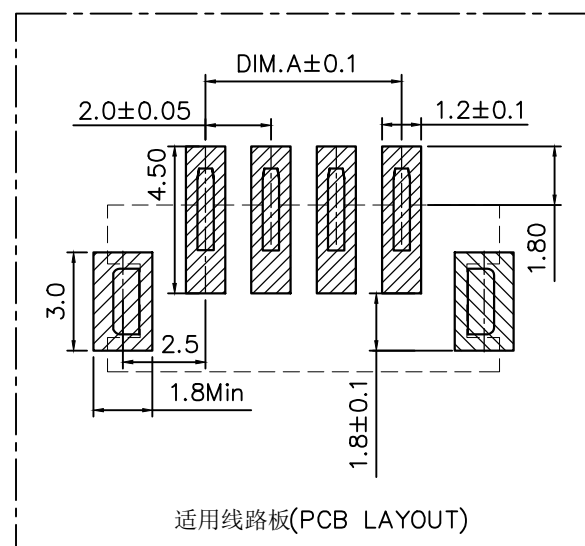

| 2 | 插针 | 铜 | 镀锡 | |
|----|----|-----|-------|----|
| 1 | 基座 | LCP | 本色 | |
| 序号 | 品名 | 材质 | 电镀/颜色 | 备注 |

| | | | | | |
|---|---|--|--------------------|--|--|
| | 深圳市虹成电子有限公司 TITLE 针座 | | PART NO HCZZ0398-7 | | |
| | GENERAL TOLERANCES (UNLESS SPECIFIED) | 比列 SCALE 1:1 | | | |
| X. ±0.50 .XX ±0.10 .X ±0.20 .XXX ±0.05 ANGLES ±1° | 单位 UNIT MM 张数 PART NO 1 OF 1 版本 REV A | 制图 DRAW AhYe 审核 CHECKED 夏操云 批准 APPROVE 赵亮亮 | | | |