

标记 MARK	ECN编号/变更内容 ECN NO/DEFINITION	修改 REVISE	日期 DATE	核准 APPROVE

CKI	DIM A	DIM B	DIM C
2	2.00	4.90	8.00
3	4.00	6.90	10.00
4	6.00	8.90	12.00
5	8.00	10.90	14.00
6	10.00	12.90	16.00
7	12.00	14.90	18.00
8	14.00	16.90	20.00
9	16.00	18.90	22.00
10	18.00	20.90	24.00
11	20.00	22.90	26.00
12	22.00	24.90	28.00
13	24.00	26.90	30.00
14	26.00	28.90	32.00
15	28.00	30.90	34.00
16	30.00	32.90	36.00

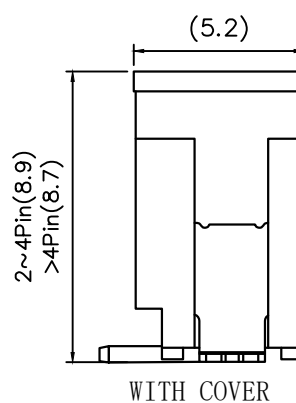
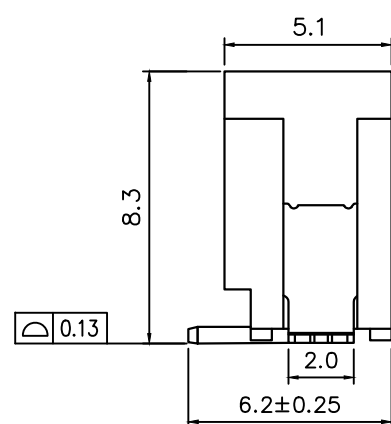
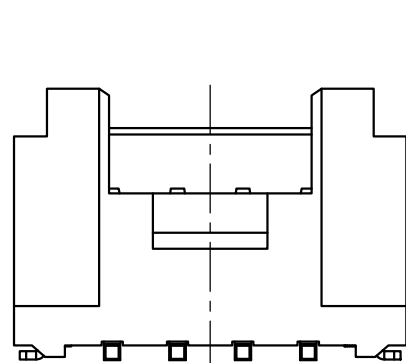
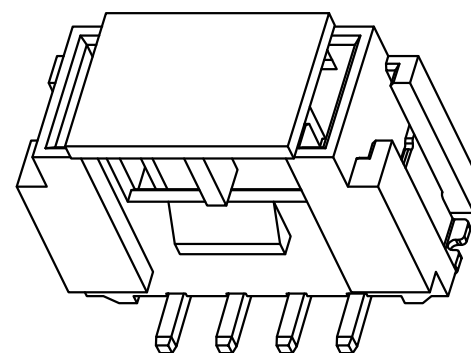
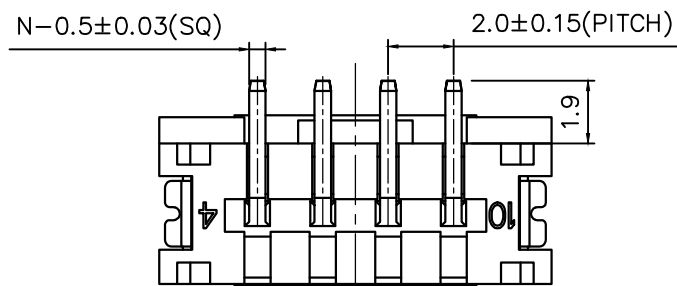
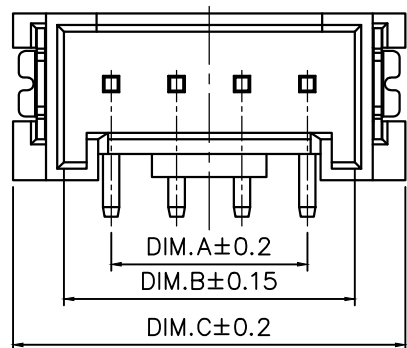

技术指标:

1. 温度范围: -40°C~85°C
2. 额定电压: 200V, AC
3. 接触电阻: ≤55mΩ (Initial) per contact
≤25mΩ Change allowed
4. 绝缘电阻: ≥1000MΩ

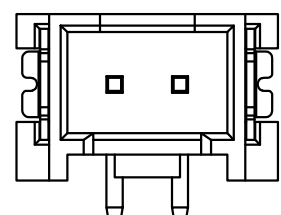

2P 结构样式

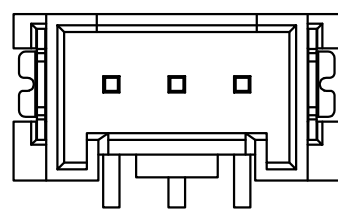

3P 结构样式

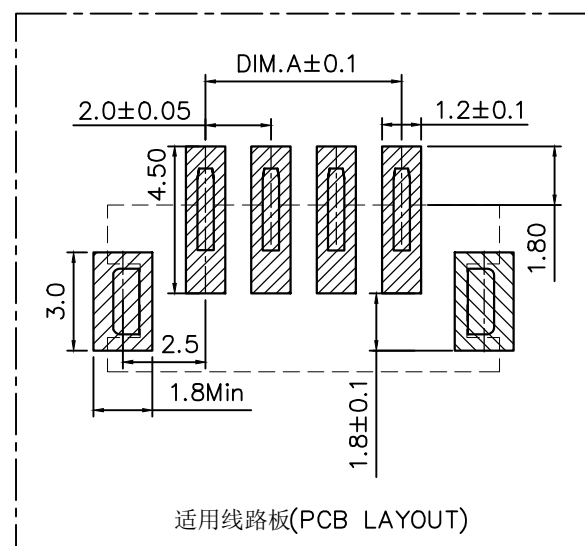

适用线路板(PCB LAYOUT)

2	插针	铜	镀锡	
1	基座	LCP	本色	
序号	品名	材质	电镀/颜色	备注

	深圳市虹成电子有限公司		品名 TITLE	针座	
			料号 PART NO	HCZZ0398-8	
GENERAL TOLERANCES (UNLESS SPECIFIED)		比列 SCALE	1:1		
X. ±0.50 .XX ±0.10		单位 UNIT	MM		
.X ±0.20 .XXX ±0.05		张数 PART NO	1 OF 1		
ANGLES ±1°		版本 REV	A	制图 DRAW	AhYe
				审核 CHECKED	夏操云
				批准 APPROVE	赵亮亮

