

标记 MARK	ECN编号/变更内容 ECN NO/DEFINITION	修改 REVISE	日期 DATE	核准 APPROVE

CKI	DIM A	DIM B	DIM C
2	2.00	4.90	8.00
3	4.00	6.90	10.00
4	6.00	8.90	12.00
5	8.00	10.90	14.00
6	10.00	12.90	16.00
7	12.00	14.90	18.00
8	14.00	16.90	20.00
9	16.00	18.90	22.00
10	18.00	20.90	24.00
11	20.00	22.90	26.00
12	22.00	24.90	28.00
13	24.00	26.90	30.00
14	26.00	28.90	32.00
15	28.00	30.90	34.00
16	30.00	32.90	36.00

$N-0.5 \pm 0.03(SQ)$ $2.0 \pm 0.15(PITCH)$

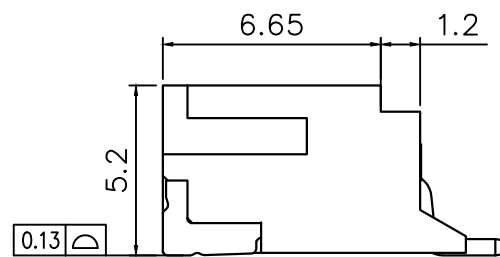
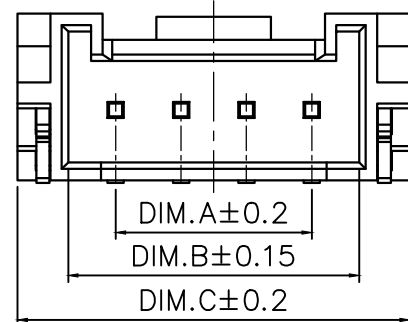
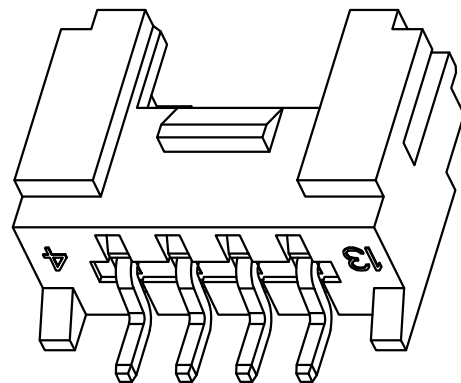
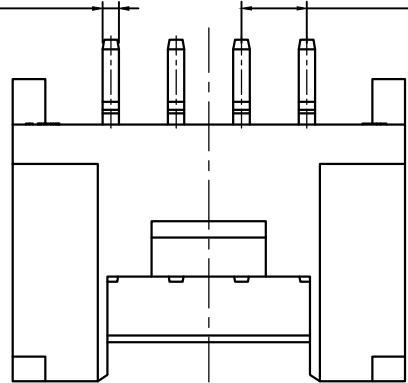

技术指标:

1. 温度范围: $-40^{\circ}C \sim 85^{\circ}C$
2. 额定电压: 200V, AC
3. 接触电阻: $\leq 55m\Omega$ (Initial) per contact
 $\leq 25m\Omega$ Change allowed
4. 绝缘电阻: $\geq 1000M\Omega$

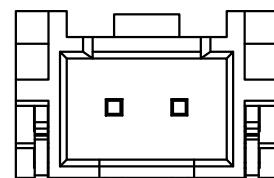
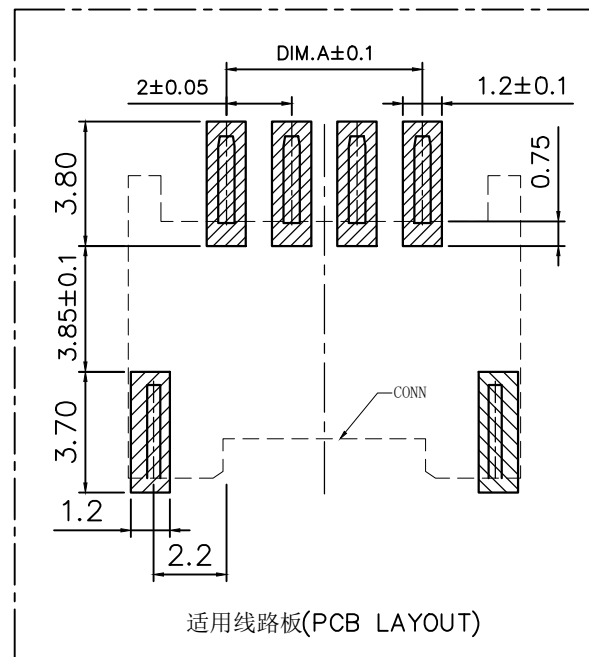
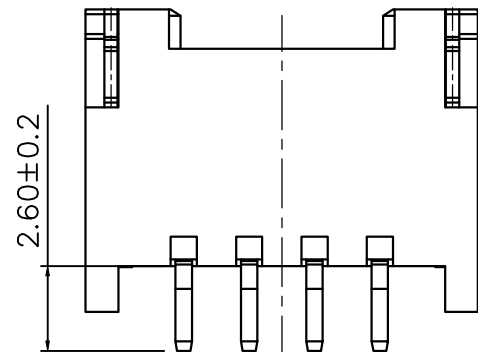

2P结构样式

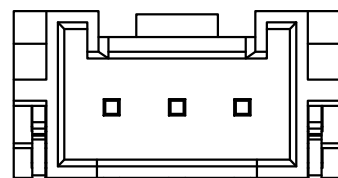

3P结构样式

序号	品名	材质	电镀/颜色	备注
2	插针	铜	镀锡	
1	基座	LCP	本色	

	深圳市虹成电子有限公司 品名 TITLE: 针座 料号 PART NO: HCZZ0383-8		
	GENERAL TOLERANCES (UNLESS SPECIFIED) X. ± 0.50 .XX ± 0.10 .X ± 0.20 .XXX ± 0.05 ANGLES $\pm 1^{\circ}$	比列 SCALE: 1:1 单位 UNIT: MM 张数 PART NO: 1 OF 1 版本 REV: A	

