

标记 MARK	ECN编号/变更内容 ECN NO/DEFINITION	修改 REVISE	日期 DATE	核准 APPROVE

Pin	DIM A	DIM B	DIM C	DIM D
2	6.00	2.00	4.90	0.80
3	8.00	4.00	6.90	2.80
4	10.00	6.00	8.90	4.80
5	12.00	8.00	10.90	6.80
6	14.00	10.00	12.90	8.80
7	16.00	12.00	14.90	10.80
8	18.00	14.00	16.90	12.80
9	20.00	16.00	18.90	14.80
10	22.00	18.00	20.90	16.80
11	24.00	20.00	22.90	18.80
12	26.00	22.00	24.90	20.80
13	28.00	24.00	26.90	22.80
14	30.00	26.00	28.90	24.80
15	32.00	28.00	30.90	26.80
16	34.00	30.00	32.90	28.80

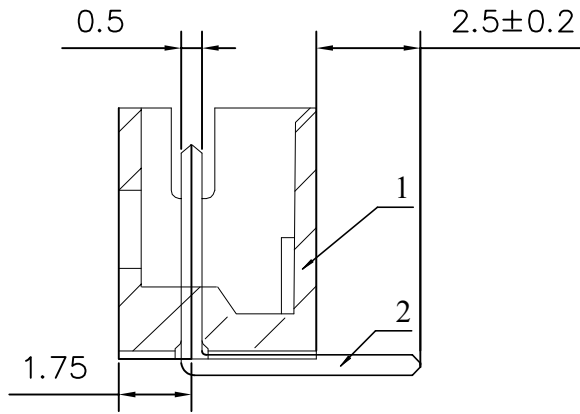
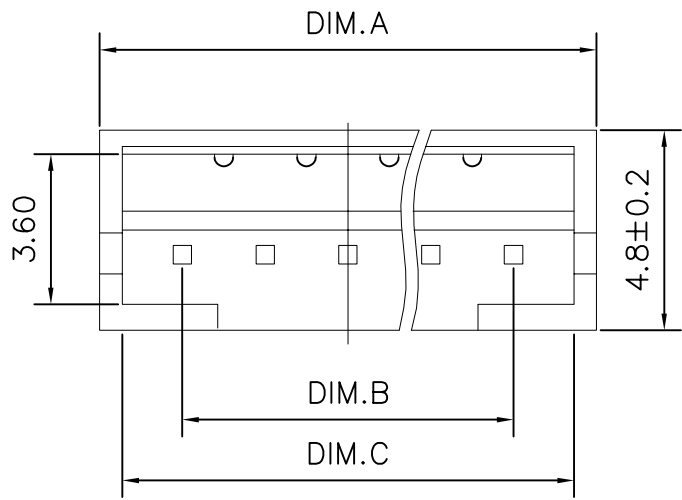

技术要求:

- 适应基板厚度: 1.2mm~1.6mm
- 温度范围: -25°C~85°C
- 额定电压: 250V AC/DC
- 额定电流: 1A
- 绝缘电阻: ≥1000MΩ
- 耐压: 800V AC/minute

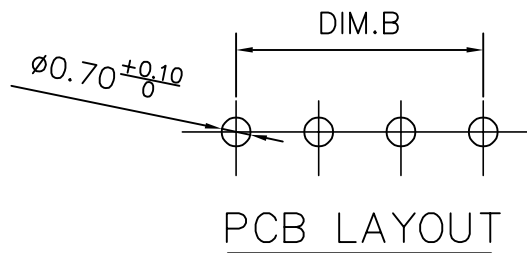
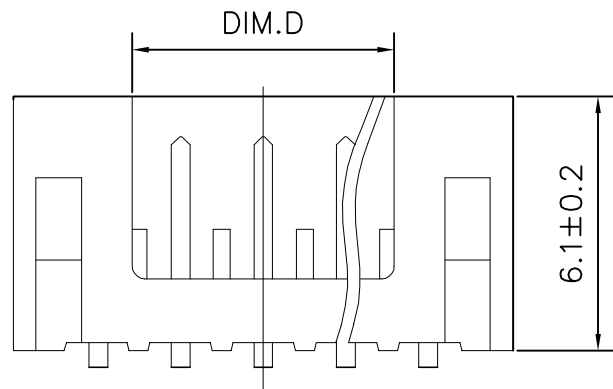

2	插针	铜	镀锡	
1	基座	PA66	米色	
序号	品名	材质	电镀/颜色	备注

	深圳市虹成电子有限公司		品名 TITLE	针座	
			料号 PART NO	HCZZ0295-6	
GENERAL TOLERANCES (UNLESS SPECIFIED)		比列 SCALE	1:1		
X.X ±0.35 X. ±3.00'		单位 UNIT	MM		
X.XX ±0.25 X.X' ±2.00'		张数 PART NO	1 OF 1	制图 DRAW	AhYe
X.XXX ±0.15 X.XX' ±1.00'		版本 REV	A	审核 CHECKED	夏操云
				批准 APPROVE	赵亮亮

