

标记 MARK	ECN编号/变更内容 ECN NO/DEFINITION	修改 REVISE	日期 DATE	核准 APPROVE

Pin	DIM A	DIM B	DIM C
2	4.50	1.50	3.60
3	6.00	3.00	5.10
4	7.50	4.50	6.60
5	9.00	6.00	8.10
6	10.50	7.50	9.60
7	12.00	9.00	11.10
8	13.50	10.50	12.60
9	15.00	12.00	14.10
10	16.50	13.50	15.60
11	18.00	15.00	17.10
12	19.50	16.50	18.60
13	21.00	18.00	20.10
14	22.50	19.50	21.60
15	24.00	21.00	23.10
16	25.50	22.50	24.60

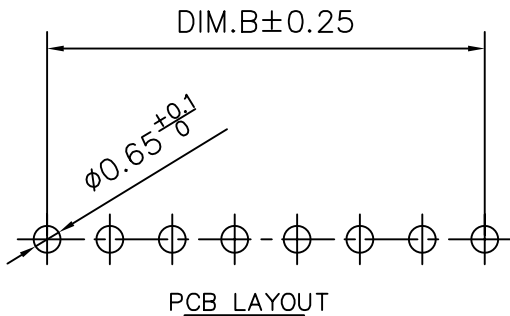
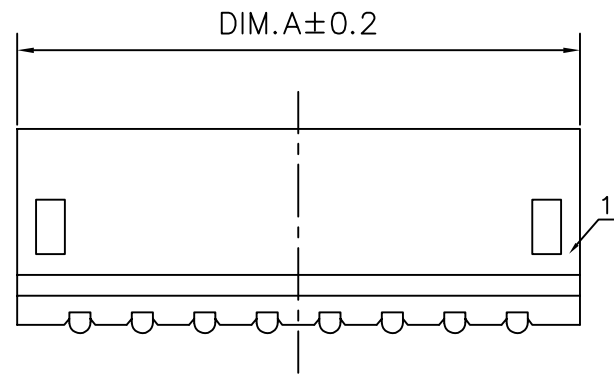
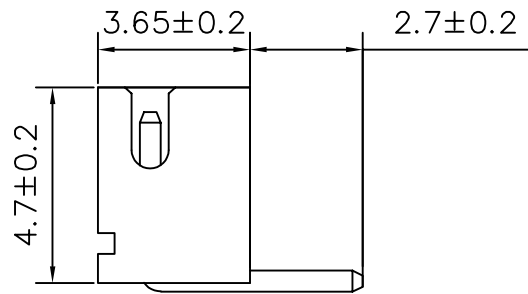
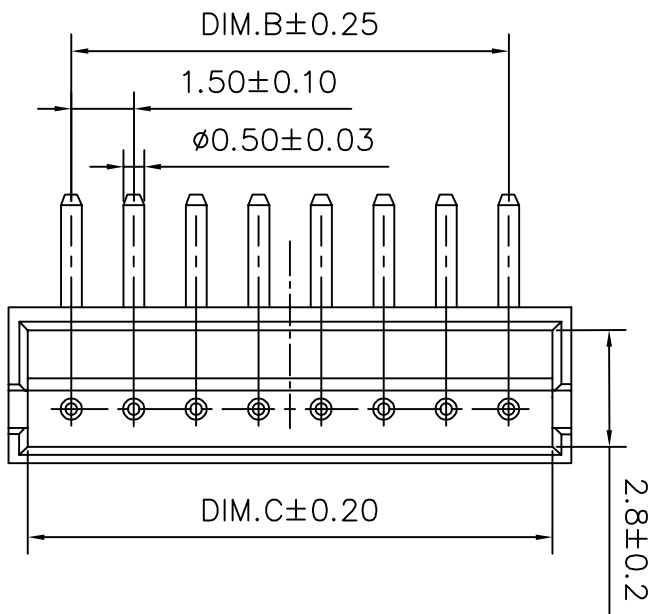

技术要求:

- 适应基板厚度: 1.2mm~1.6mm
- 温度范围: -25°C~85°C
- 额定电压: 250V AC/DC
- 额定电流: 1A
- 绝缘电阻: ≥1000MΩ
- 耐压: 800V AC/minute

2	插针	铜	镀锡	
1	底座	PA66	米色	
序号	品名	材质	电镀/颜色	备注

	深圳市虹成电子有限公司		品名 TITLE	针座	
			料号 PART NO	HCZZ0002-2	
GENERAL TOLERANCES (UNLESS SPECIFIED)		比列 SCALE	1:1		
X.X ±0.35 X. ±3.00'		单位 UNIT	MM		
X.XX ±0.25 X.X' ±2.00'		张数 PART NO	1 OF 1	制图 DRAW	AhYe
X.XXX ±0.15 X.XX' ±1.00'		版本 REV	A	审核 CHECKED	夏操云
				批准 APPROVE	赵亮亮

