

标记 MARK	ECN编号/变更内容 ECN NO/DEFINITION	修改 REVISE	日期 DATE	核准 APPROVE

Pin	DIM A	DIM B
2	4.40	1.25
3	5.65	2.50
4	6.90	3.75
5	8.15	5.00
6	9.40	6.25
7	10.65	7.50
8	11.90	8.75
9	13.15	10.00
10	14.40	11.25
11	15.65	12.50
12	16.90	13.75
13	18.15	15.00
14	19.40	16.25
15	20.65	17.50
16	21.90	18.75

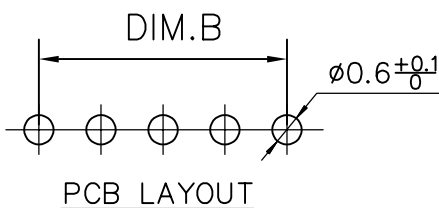
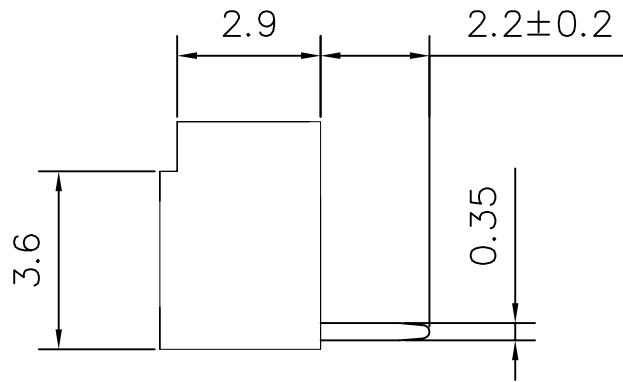
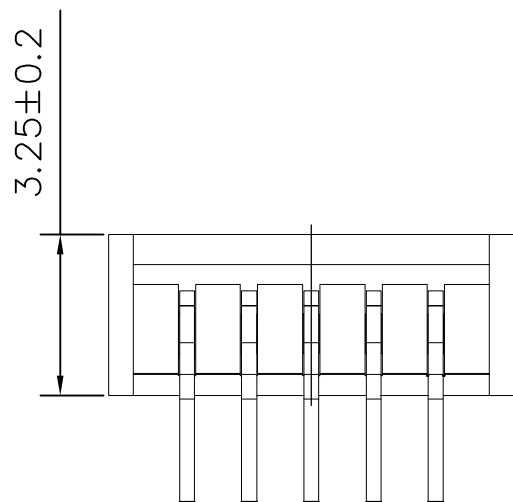
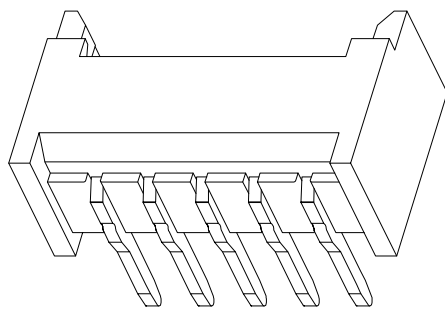
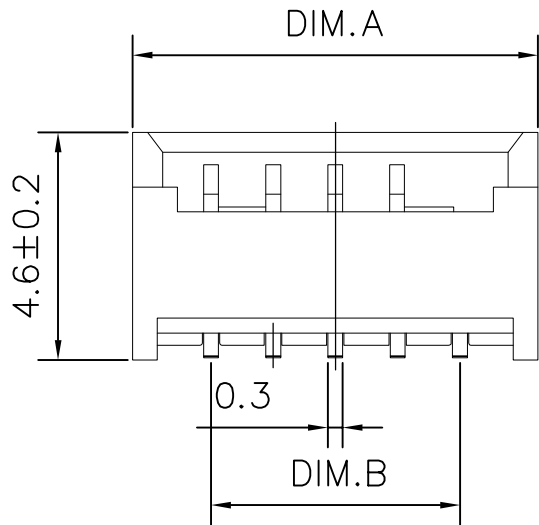

技术要求:

- 适应基板厚度: 1.2mm~1.6mm
- 温度范围: -25°C~85°C
- 额定电压: 125V AC/DC
- 额定电流: 1A
- 接触电阻: ≤0.02Ω
- 绝缘电阻: ≥100MΩ
- 耐 压: 500V AC/minute

序号	品名	材质	电镀/颜色	备注
2	插针	铜	镀锡	
1	基座	PA6T	米色	

	深圳市虹成电子有限公司		品名 TITLE	针座	
			料号 PART NO	HCZZ0570-5	
GENERAL TOLERANCES (UNLESS SPECIFIED)		比列 SCALE	1:1		
		单位 UNIT	MM		
X.X ±0.35 X.X' ±3.00'		张数 PART NO	1 OF 1	制图 DRAW	AhYe
X.XX ±0.25 X.X'' ±2.00'		版本 REV	A	审核 CHECKED	夏操云
X.XXX ±0.15 X.XX' ±1.00'				批准 APPROVE	赵亮亮

