

标记 MARK	ECN编号/变更内容 ECN NO./DEFINITION	修改 REVISE	日期 DATE	核准 APPROVE

Pin	A	B	C	D
2	1.25	3.85	5.80	0.50
3	2.50	5.10	7.05	1.75
4	3.75	6.35	8.30	2.00
5	5.00	7.60	9.55	3.26
6	6.25	8.85	10.80	4.52
7	7.50	10.10	12.05	4.50
8	8.75	11.35	13.30	4.50
9	10.00	12.60	14.55	4.50
10	11.25	13.85	15.80	6.50
11	12.50	15.10	17.05	6.50
12	13.75	16.35	18.30	6.50
13	15.00	17.60	19.55	6.50
14	16.25	18.85	20.80	6.50
15	17.50	20.10	22.05	6.50
16	18.75	21.35	23.30	6.50

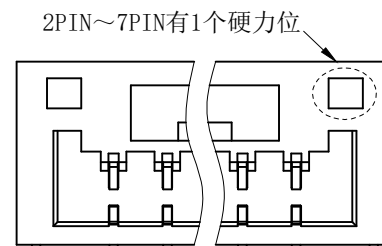
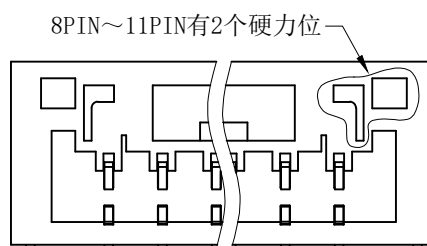
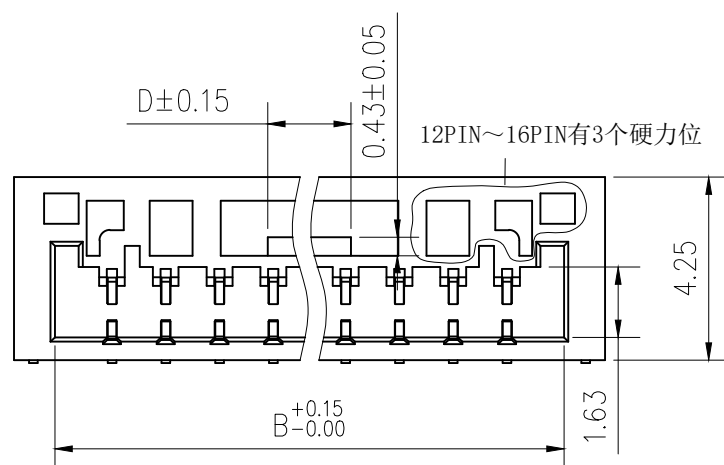
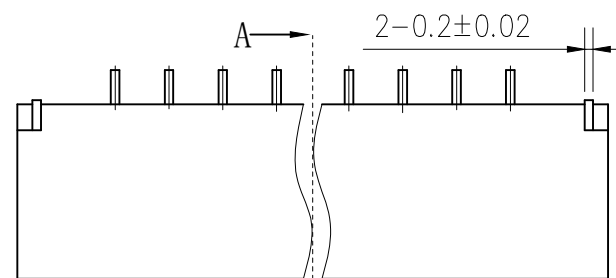
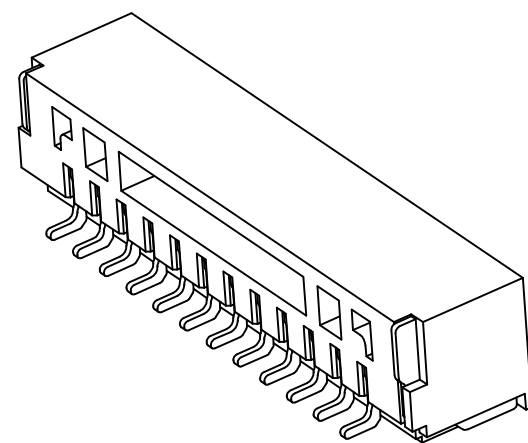
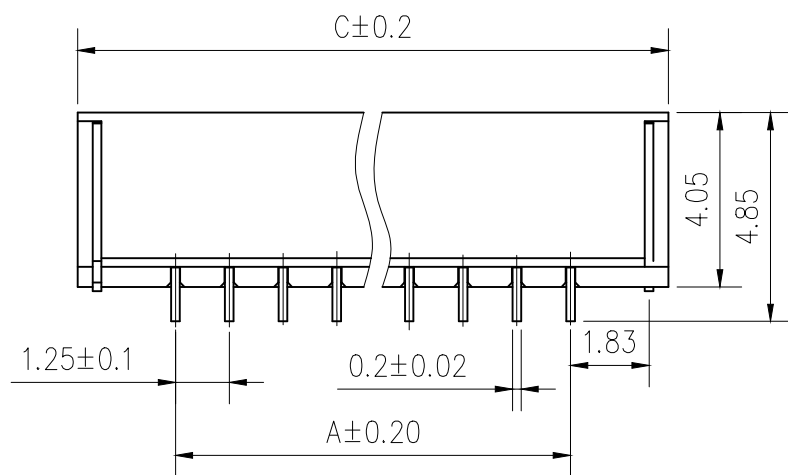

1. 技术参数:

- 1.1 额定电流: 1.0A AC/DC
- 1.2 额定电压: 125V
- 1.3 耐电压: 500V ACminute
- 1.4 接触电阻: 20mΩ MAX
- 1.5 绝缘电阻: 500MΩ MIN
- 2.0 工作温度: -25℃~+85℃

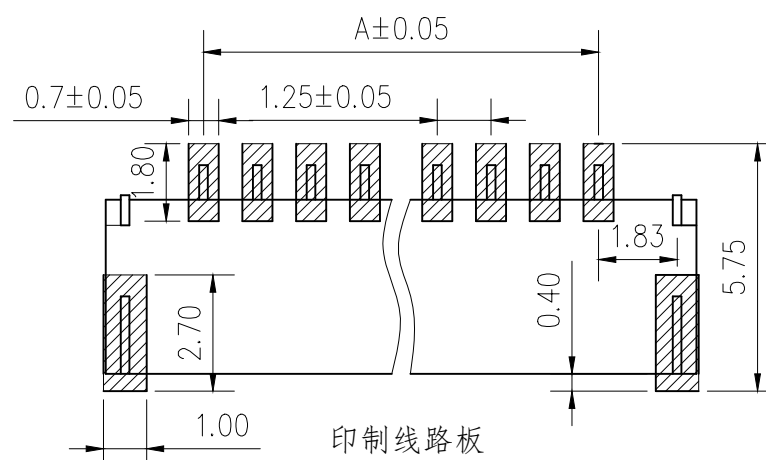
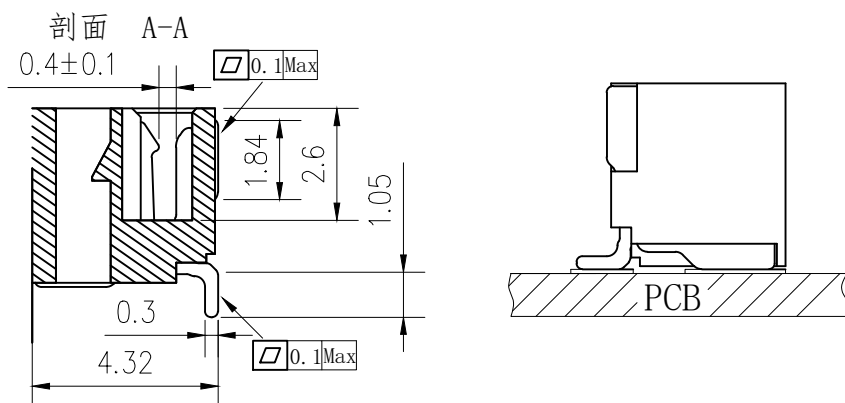

2	插针	铜	镀锡	
1	基座	LCP	本色	
序号	品名	材质	电镀/颜色	备注

深圳市虹成电子有限公司

品名
TITLE
针座

料号
PART NO
HCZZ0014-6

GENERAL TOLERANCES
(UNLESS SPECIFIED)

X.X ±0.30

X.XX ±0.20

X.XXX ±0.10

Angle ±3.0°

比列
SCALE
1:1

单位
UNIT
MM

张数
PART NO
1 OF 1

版本
REV
A

制图
DRAW
AhYe

审核
CHECKED
夏操云

批准
APPROVE
赵亮亮