

标记 MARK	ECN编号/变更内容 ECN NO/DEFINITION	修改 REVISE	日期 DATE	核准 APPROVE

PIN数	A±0.1	B±0.1	C±0.1
2P	4.30	1.00	3.25
3P	5.30	2.00	4.25
4P	6.30	3.00	5.25
5P	7.30	4.00	6.25
6P	8.30	5.00	7.25
7P	9.30	6.00	8.25
8P	10.30	7.00	9.25

A

B

C

D

E

F

G

A

B

C

D

E

F

G

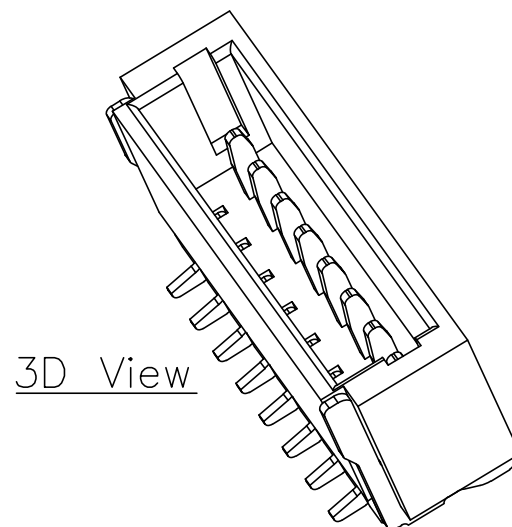
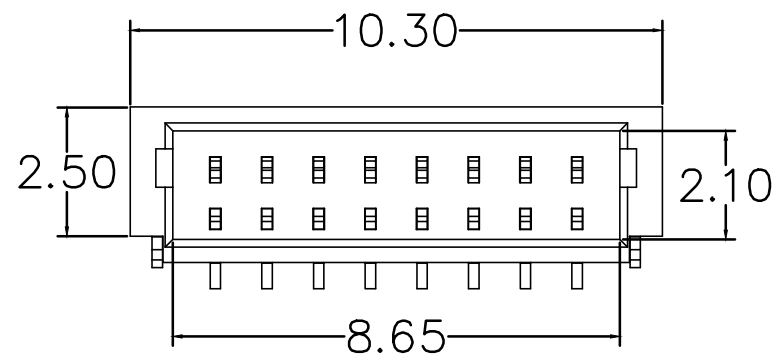

3D View

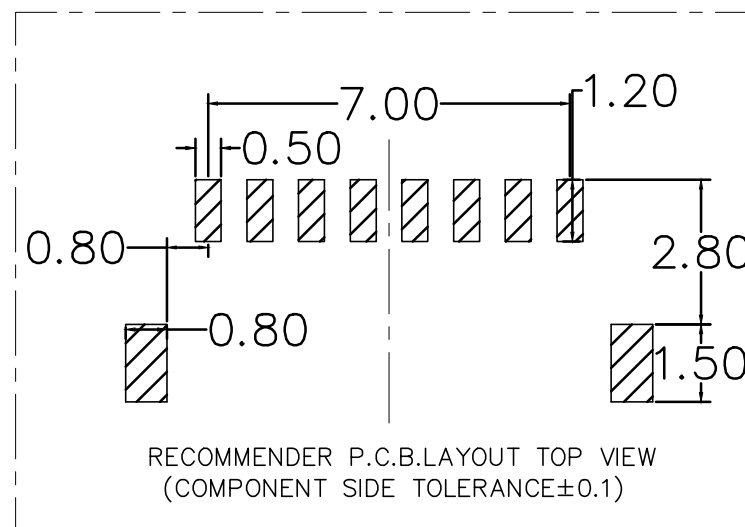
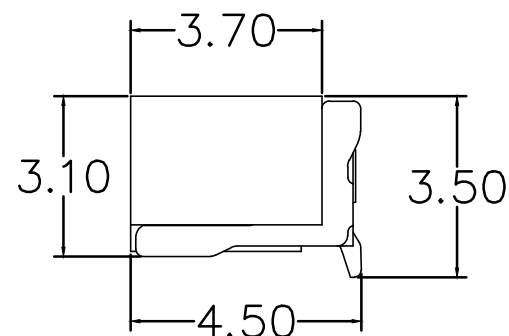
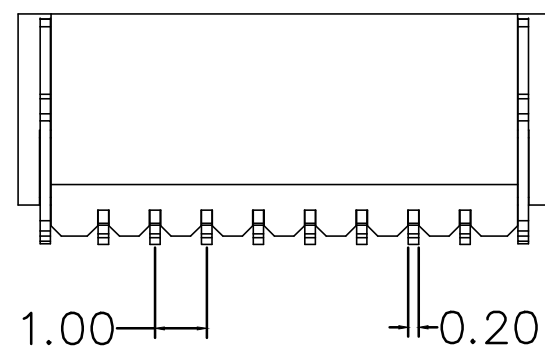
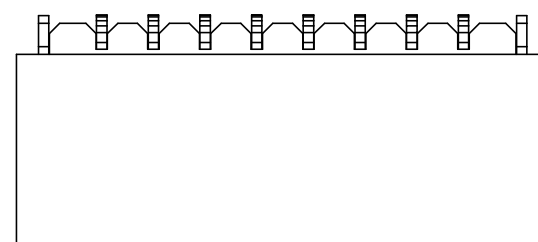
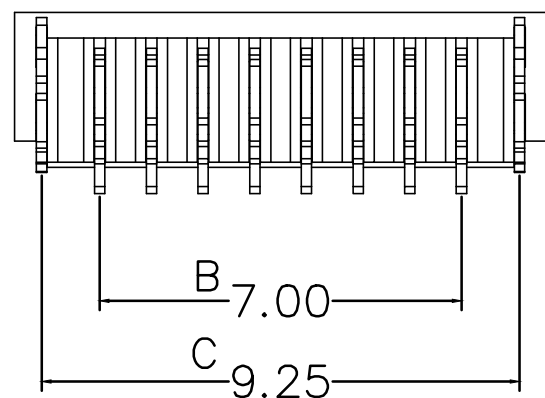

Specifications:

1. Rated Voltage : 50V AC/DC
2. Rated Current : 1A AC,DC
3. Withstand Voltage : 200V AC/minute
4. Contact Resistance : 50mΩ(MAX.)
5. Insulation Resistance : 100MΩ(MIN.)
6. Storage Temperature Range: -40°C~+85°C;
7. Operation Temperature Range: -25°C~+70°C;

2	插针	铜	镀镍锡	
1	底座	LCP	本色	
序号	品名	材质	电镀/颜色	备注

 深圳市虹成电子有限公司	品名 TITLE	针座		
	料号 PART NO	HCZZ0039-8		
UNLESS OTHERWISE, GENERAL TOLERANCE:	比列 SCALE	1:1		
X. xxx ±0.05 X. xx ±0.15 X. x ±0.25	单位 UNIT	MM	制图 DRAW	AhYe
ANGULAR: X. xx° ±1° X. x° ±3° X. ° ±5°	张数 PART NO	1 OF 1	审核 CHECKED	夏操云
	版本 REV	A	批准 APPROVE	赵亮亮

