

标记 MARK	ECN编号/变更内容 ECN NO/DEFINITION	修改 REVISE	日期 DATE	核准 APPROVE

Pin	A	B	C
2	0.80	3.90	1.90
3	1.60	4.70	2.70
4	2.40	5.50	3.50
5	3.20	6.30	4.30
6	4.00	7.10	5.10
7	4.80	7.90	5.90
8	5.60	8.70	6.70
9	6.40	9.50	7.50
10	7.20	10.30	8.30
11	8.00	11.10	9.10
12	8.80	11.90	9.90
13	9.60	12.70	10.70
14	10.40	13.50	11.50
15	11.20	14.30	12.30
16	12.00	15.10	13.10

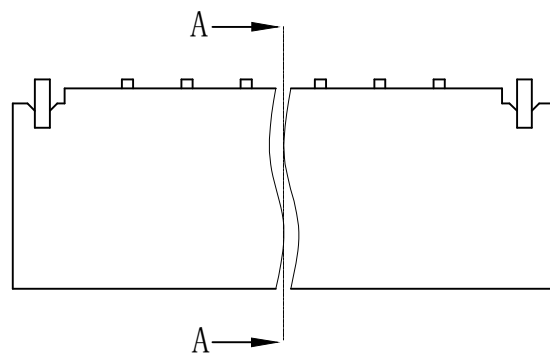

1. 技术参数:
- 1.1 额定电流: 0.5A AC/DC
  - 1.2 额定电压: 50V AC/DC
  - 1.3 耐电压: 500V ACminute
  - 1.4 接触电阻: 20mΩ MAX
  - 1.5 绝缘电阻: 100MΩ MIN
  - 2.0 工作温度: -25℃ ~ +85℃

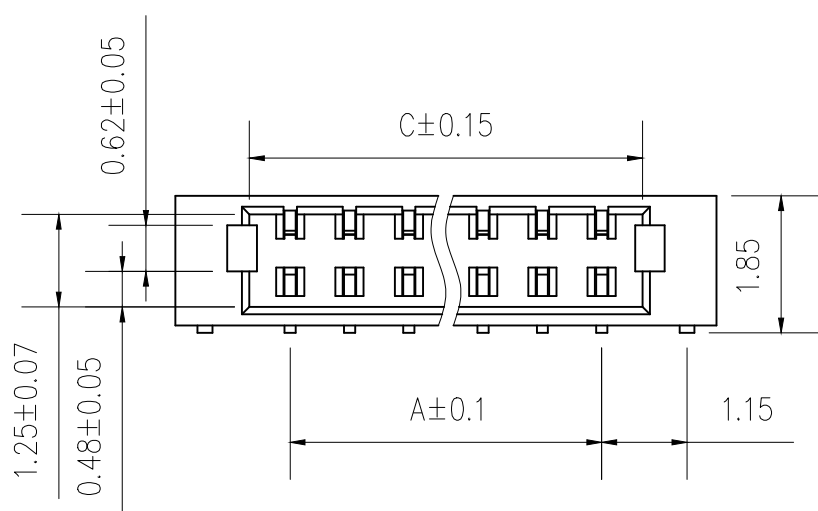
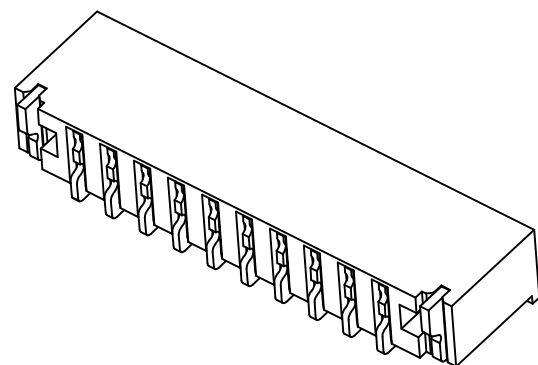
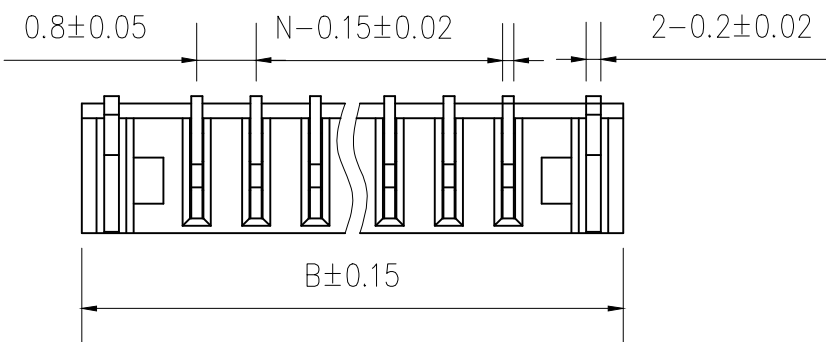
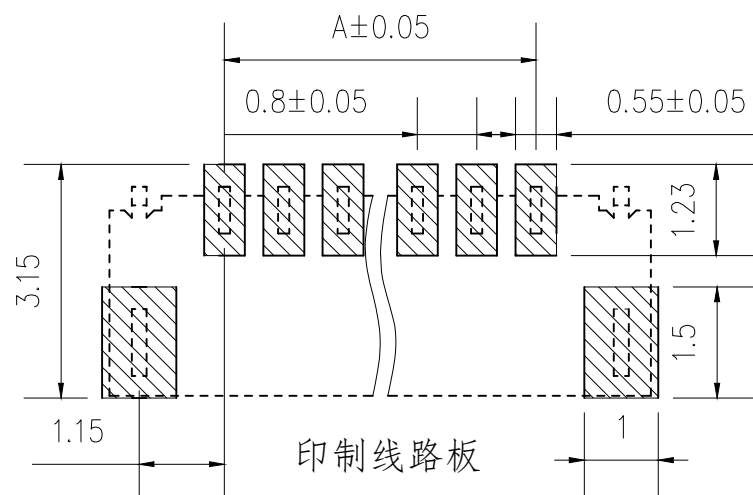
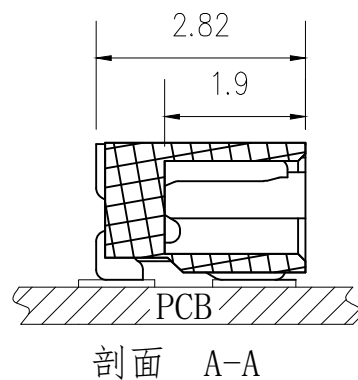
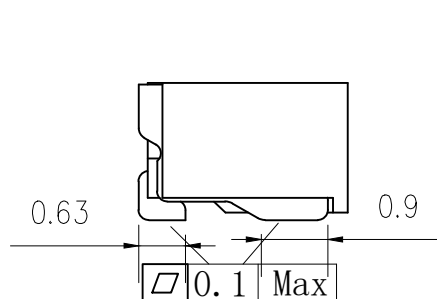

2	插针	铜	镀锡	
1	基座	LCP	本色	
序号	品名	材质	电镀/颜色	备注

	深圳市虹成电子有限公司		品名 TITLE	针座	
			料号 PART NO	HCZZ0536-5	
GENERAL TOLERANCES (UNLESS SPECIFIED)		比列 SCALE	1:1		
X.X	±0.30	单位 UNIT	MM	制图 DRAW	AhYe
X.XX	±0.20	张数 PART NO	1 OF 1	审核 CHECKED	夏操云
X.XXX	±0.10	版本 REV	A	批准 APPROVE	赵亮亮
Angle	±3.0°				