

标记 MARK	ECN编号/变更内容 ECN NO/DEFINITION	修改 REVISE	日期 DATE	核准 APPROVE

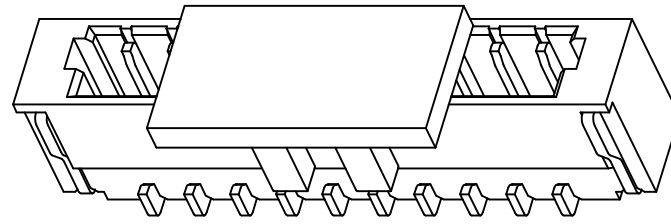

Pin	A	B	C
2	0.80	3.90	1.90
3	1.60	4.70	2.70
4	2.40	5.50	3.50
5	3.20	6.30	4.30
6	4.00	7.10	5.10
7	4.80	7.90	5.90
8	5.60	8.70	6.70
9	6.40	9.50	7.50
10	7.20	10.30	8.30
11	8.00	11.10	9.10
12	8.80	11.90	9.90
13	9.60	12.70	10.70
14	10.40	13.50	11.50
15	11.20	14.30	12.30
16	12.00	15.10	13.10

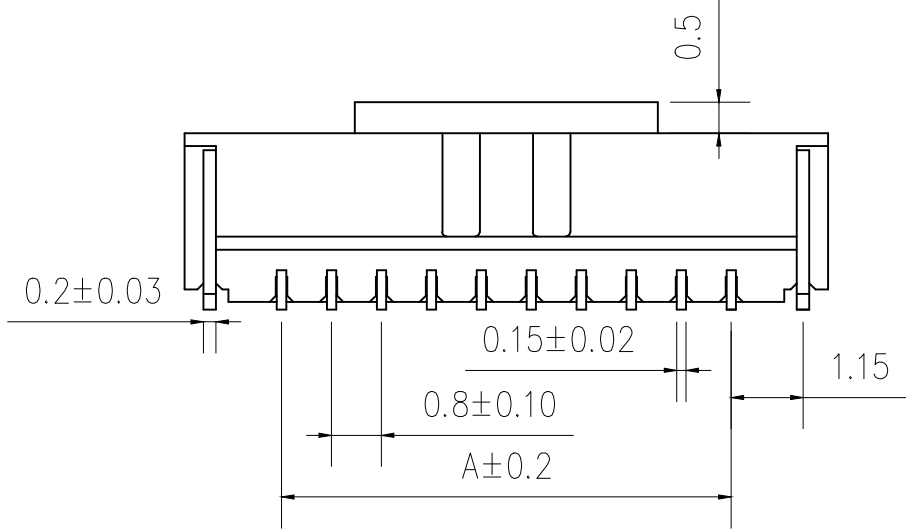
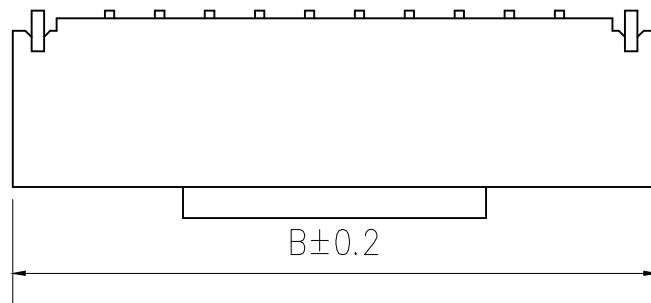
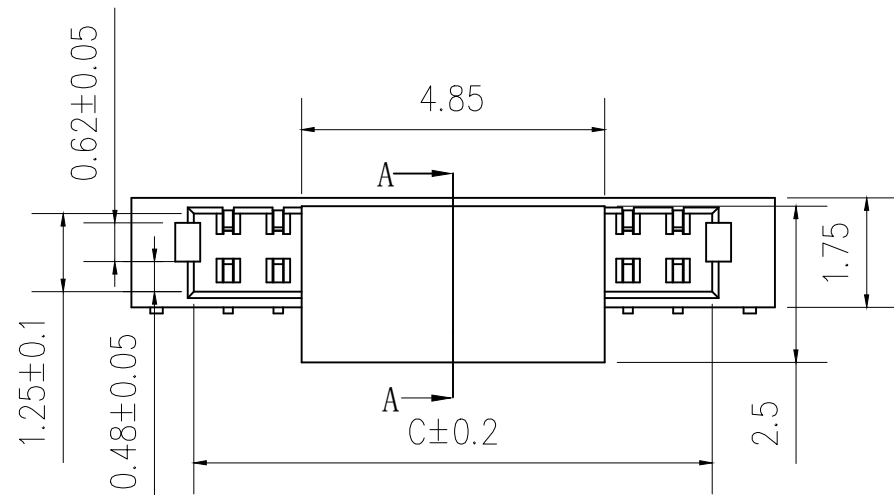

1. 技术参数:
- 1.1 额定电流: 0.5A AC/DC
 - 1.2 额定电压: 50V AC/DC
 - 1.3 耐电压: 500V ACminute
 - 1.4 接触电阻: 20mΩ MAX
 - 1.5 绝缘电阻: 100MΩ MIN
 - 2.0 工作温度: -25℃~+85℃

2	插针	铜	镀锡	
1	基座	LCP	本色	
序号	品名	材质	电镀/颜色	备注

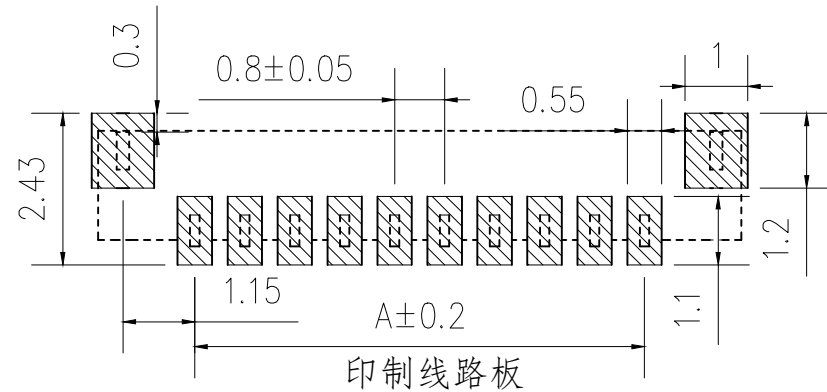
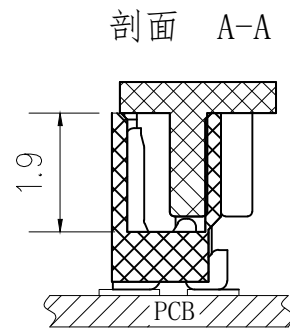
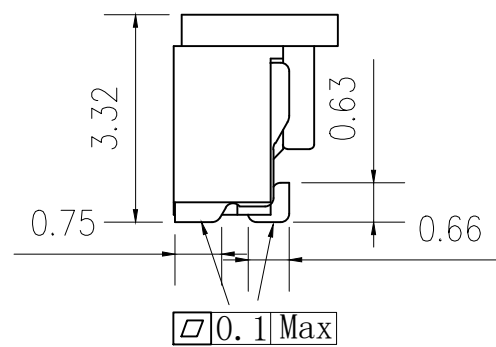

 深圳市虹成电子有限公司

品名 TITLE: 针座
料号 PART NO: HCZZ0530-5

GENERAL TOLERANCES (UNLESS SPECIFIED):
X.X ±0.30
X.XX ±0.20
X.XXX ±0.10
Angle ±3.0°

比列 SCALE: 1:1
单位 UNIT: MM
张数 PART NO: 1 OF 1
版本 REV: A

制图 DRAW: AhYe
审核 CHECKED: 夏操云
批准 APPROVE: 赵亮亮

